



For Android™ 11

Enterprise Mobility

PM75

User Manual

Instruction

This manual provides information about basic features and using the PM75. Please read this manual carefully before using your handy payment device and peripherals to ensure safe and proper use.



Note: *Screenshots in this manual may differ from actual screens.*

Revision History

Revision	Date	Description
V01	05 Jul 2021	Initial release
V02	12 Oct 2021	Updated accessories related chapters (Accessories, RFID, etc.) Modified charging cradles' description

Instruction

PM75 SKUs

The contents of this manual can cover the following SKUs.

SKU	Part Number	Network	RAM /Flash	Scanner	Battery	Common
SKU1	PM75G3V03BJE0C	Wi-Fi/BT	3G/32G	N3601 SR	Standard	Android 11, NFC, Rear camera
SKU1-1	PM75G3V04BJE0C	Wi-Fi/BT	3G/32G	N3601 SR	Extended	
SKU2	PM75G3Q03BJE0C	Wi-Fi/BT	3G/32G	N6603 SR	Standard	
SKU2-1	PM75G3Q04BJE0C	Wi-Fi/BT	3G/32G	N6603 SR	Extended	
SKU3	PM75G3Q04DJE0C	Wi-Fi/BT	4G/64G	N6603 SR	Extended	
SKU4	PM75G6V03BJE0C	LTE, GPS, Wi-Fi/BT	3G/32G	N3601 SR	Standard	
SKU4-1	PM75G6V04BJE0C	LTE, GPS, Wi-Fi/BT	3G/32G	N3601 SR	Extended	
SKU5	PM75G6Q03BJE0C	LTE, GPS, Wi-Fi/BT	3G/32G	N6603 SR	Standard	
SKU6	PM75G6V03DJE0C	LTE, GPS, Wi-Fi/BT	4G/64G	N3601 SR	Standard	
SKU7	PM75G6Q03DJE0C	LTE, GPS, Wi-Fi/BT	4G/64G	N6603 SR	Standard	

Table of Contents

INSTRUCTION	1
Revision History	1
PM75 SKUs	2
GETTING STARTED	7
Device Parts	7
Product Standard Accessories.....	9
Install SIM & SD card.....	10
Install & Remove Battery	12
Install the battery	12
Remove the battery	13
Battery Hot Swap.....	13
Charge the device.....	14
Battery Specification	14
Smart Charging	14
Charge with power adapter.....	16
Charging Cradle	17
LED Indicator	20
Turn on & off PM75.....	21
Use a Touch Screen	22
Controlling the touch screen	22
System navigation	24
LEARNING THE BASICS.....	26
Setup Wizard	26
Home Screen.....	27
Status bar	28
Notification panel	29

Table of Contents

Quick setting panel	30
Apps & Widget.....	31
Call.....	35
Making a call.....	35
Answering a call	37
Contacts.....	38
Add a contact.....	38
Contact detail.....	39
Message	40
MTP Connection with PC.....	41
Manage the Files	42
Lock the Screen.....	44
Settings.....	45
Adjust display brightness	45
Adjust sound.....	45
Adjust font size	46
USING THE BUTTONS	47
Screenshot.....	47
Program Buttons	47
CAMERA	49
SCANNER	50
Turn on / off the Scanner	50
ScanSettings.....	51
Basic.....	51
Options	52
Notification.....	53
Wedge	54

Table of Contents

Extended wedge	55
Symbologies	59
About	59
Scan a Barcode	60
N3601 Scanner SKU	60
N6603 Scanner SKU	60
ScanDemo	61
WIRELESS	62
Mobile Network	62
Wi-Fi	63
Bluetooth.....	64
Turn on / off	64
Pair and Connect.....	64
Unpair and Disconnect	65
Change the Bluetooth device details	66
NFC	67
RFID	68
SYSTEM MAINTENANCE	69
System information	69
On Settings.....	69
On EmKit.....	69
Check Device Health	70
OS Update	71
OS update via storage	71
OS update via OTG port.....	72
OS update via FOTA	72
Factory Data Reset.....	74

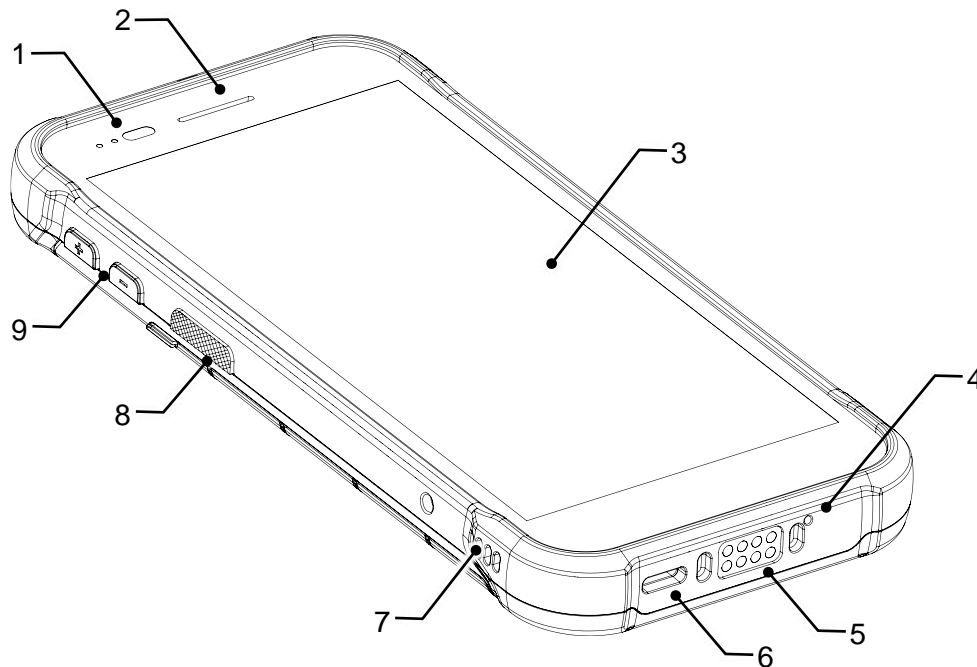
Table of Contents

Factory data reset via Settings app	74
Factory data reset via recovery mode	75
ACCESSORIES.....	76
Hand Strap.....	76
Attach hand strap	77
Gun Handle.....	79
Attach & Use gun handle	79
Attach hand strap	79
RF750 (RFID Sled)	81
Charging cradle	81
Single Slot Cradle (SSC)	81
2SC (2 Slot Cradle)	81
4SBC (4 Slot Battery Cradle).....	81
SAFETY INFORMATION.....	82
Battery Safety Information	82

Getting Started

Device Parts

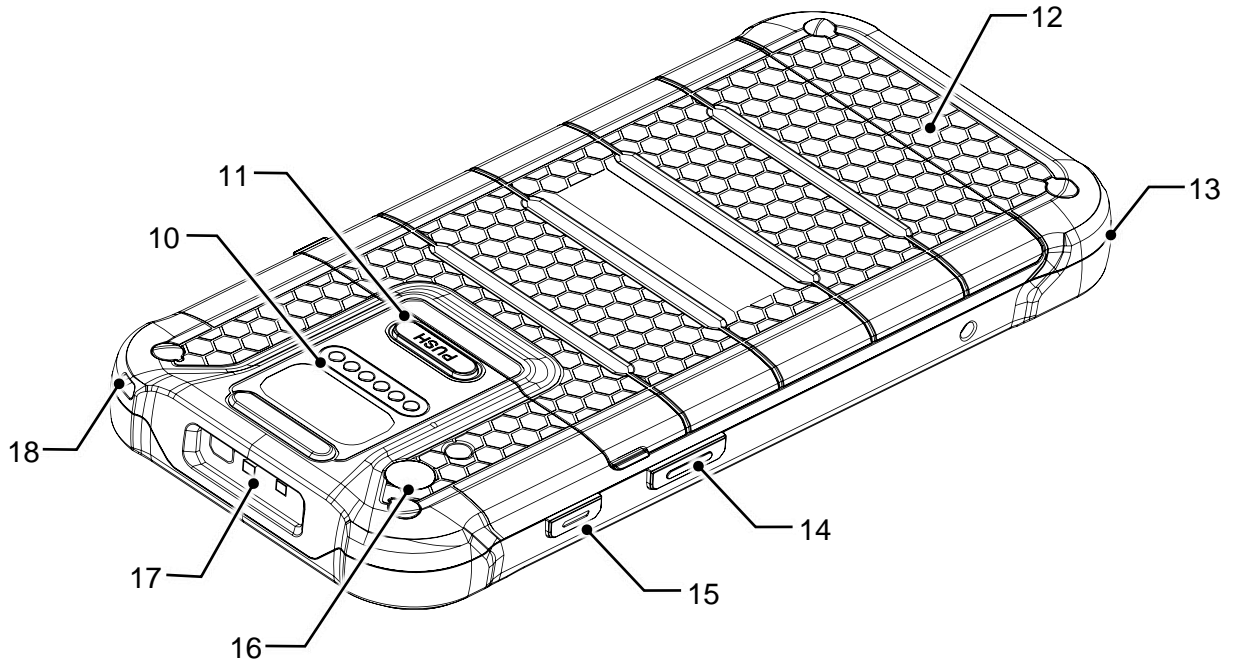
Figure 1 PM75 Front view



No	Name	Description
1	LED indicator & Sensor	Indicate the power status and notification. Find more details in LED Indicator
2	Receiver	Use with making a phone call
3	Screen	Display all operating screen
4	Microphone	Use for collecting sound
5	I/O connector for cradle	Connector for charging and communication with cradle
6	USB connector	USB Type C connector for charging and data communication
7	Speaker	Ring system sound
8	Push-To-Talk / Scan button	Use PTT function or scan a barcode by pressing (Programmable button)
9	Volume up & down button	Control the volume (Programmable button)

Getting Started

Figure 2 PM75 Rear view









No	Name	Description
10	I/O connector for sled type accessory	Connector for communication with a sled type accessory (RF750 or gun handle)
11	Battery cover release button	Press to release the battery cover and replace the battery
12	Battery cover	Protect the battery from detaching and damage
13	Hand strap hole (bottom)	Attach hand strap
14	Scan button (right)	Scan a barcode by pressing (Programmable button)
15	Power button	Turn on/off the device
16	Rear camera & Flashlight	Take a picture & Use flashlight in camera or torch mode
17	Scanner	Scan a barcode
18	Hand strap hole (top)	Attach hand strap

Getting Started

Product Standard Accessories

The following items are in the product box.

Accessory	Name
	Battery pack
	AC/DC Adapter
	Country plug
	USB type C cable
	LCD protection film
	Hand strap



Note: The images may differ from the actual accessory.

Getting Started

Install SIM & SD card

PM75 supports

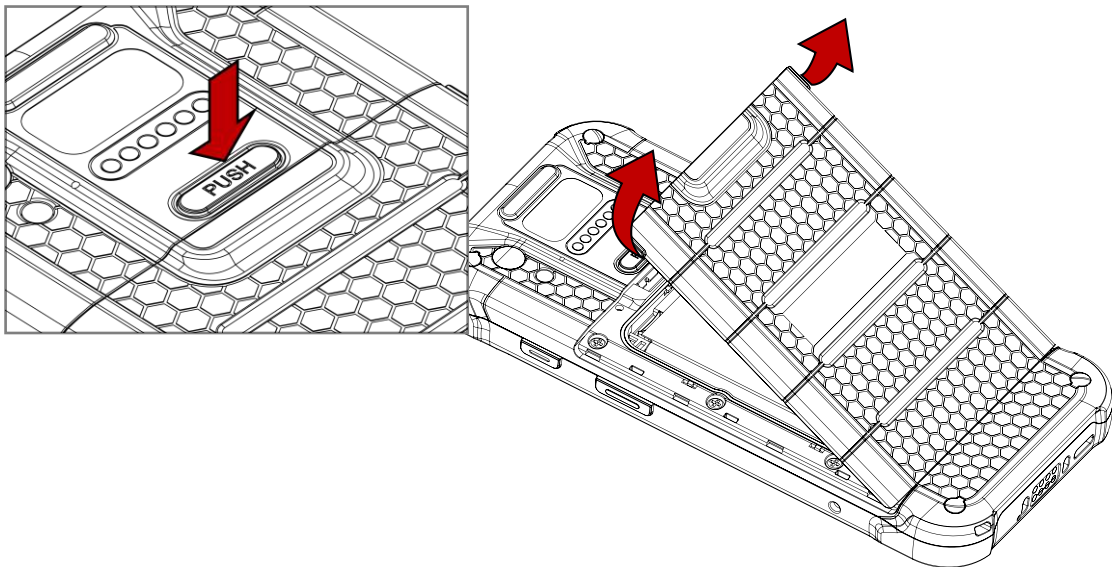
- Nano SIM card – LTE SKU (SKU4 ~ 7) only
- microSD card

To install the cards,

1. Open the battery cover while pressing the battery cover release button.

Using the small latch on both sides of the cover, pull it up.

Figure 3 Opening battery cover

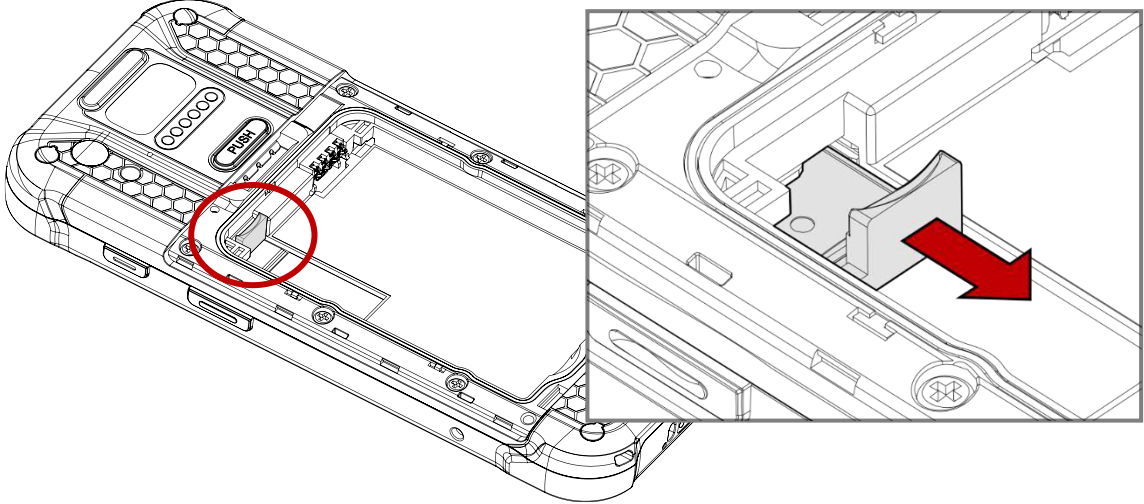


2. Remove the battery.

Getting Started

3. Gently pull out the card tray on the top of the battery slot.

Figure 4 Pulling out card tray



4. Put Nano SIM card and SD card you prepared onto each slot with the contacts facing up.

Figure 5 Placing Nano SIM card

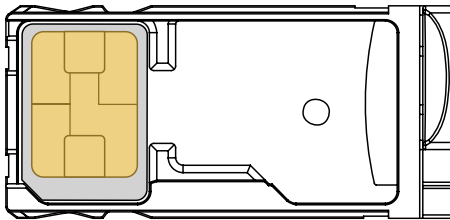
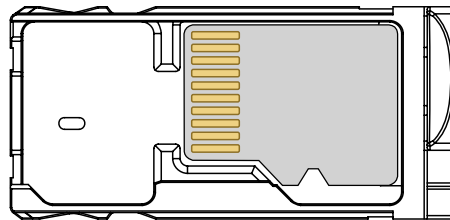


Figure 6 Placing microSD card



5. Gently insert the card tray.



Caution: Do not push the card tray into the device too hard. The card tray may be damaged.

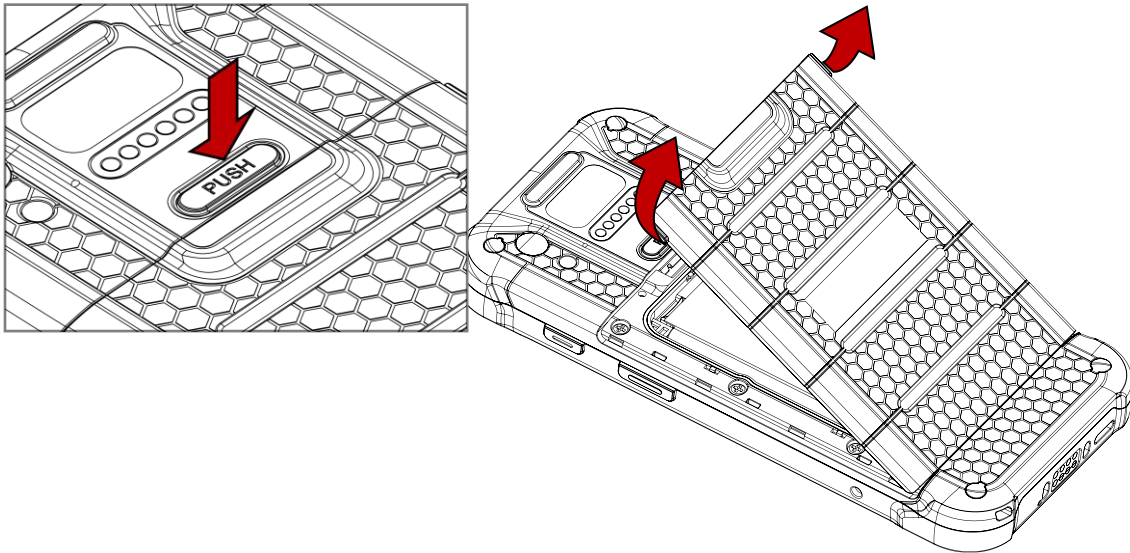
Getting Started

Install & Remove Battery

Install the battery

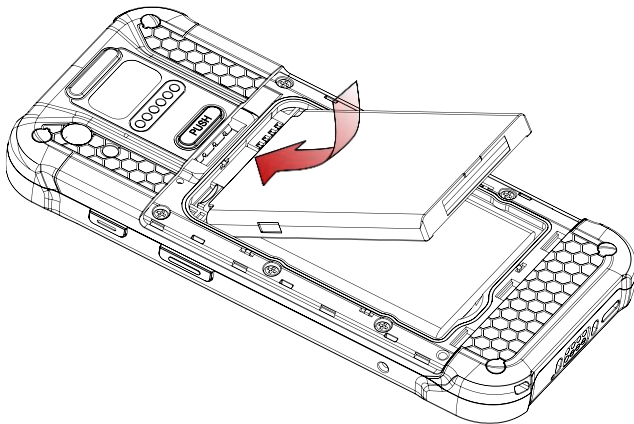
1. Open the battery cover while pressing the battery cover release button.
Using the small latch on both sides of the cover, pull it up.

Figure 7 Opening battery cover



2. Align the connector (gold contact) of the battery with the battery connector of device.
3. Insert the battery from top to bottom into the slot.

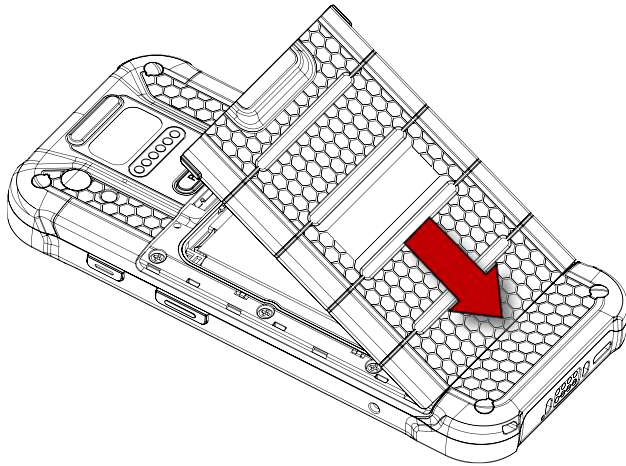
Figure 8 Inserting battery



Getting Started

- Engage the battery cover from bottom, and then press the edge of the cover to close it firmly.

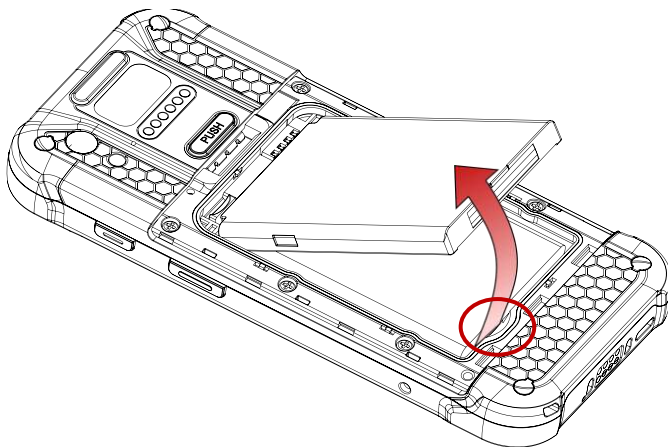
Figure 9 Closing battery cover



Remove the battery

- Open the battery cover.
- Pull the battery up using the small hole on the bottom of the battery slot.

Figure 10 Removing battery



Battery Hot Swap

PM75 supports the Battery hot swap mode which allows you to replace the battery without turning off the device. When the battery is removed from the device, the display turns off and the device enters Hot swap mode (For verification, a red LED will be turned on). In Hot swap mode, data is retained about 5 minutes.

Once you replace the battery to a new one and close the battery cover firmly, the device will come back to normal operation mode without booting process.

Getting Started

Charge the device

Before using PM75, charge the device enough to use. PM75 can be charge with power adapter or charging cradle.

Battery Specification

- Capacity:
 - Standard: 2,900mAh / 3.85V
 - Extended: 5,800mAh / 3.85V
- Rechargeable & Removable battery

Smart Charging

PM75 supports three charging modes to provide optimal battery performance for your work. Each mode controls the charging current or the maximum charging level to meet the needs.

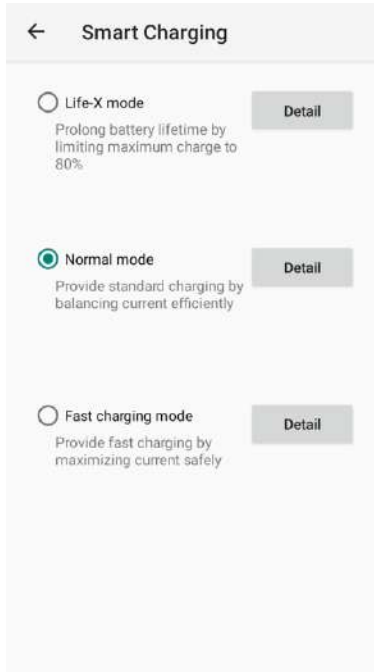
When the device is charged to the maximum charging level, the device turns to a fully charged state (Power LED lights green. Refer to [LED indicator](#)).

- **Normal mode (Default)**
 - Standard charging mode
 - Maximum charging level: 100%
- **Life-X mode**
 - limits the maximum charging level to extend the battery lifetime.
 - Maximum charging level: around 80%
- **Fast charging mode**
 - Charges PM75 faster than the other modes.
 - Maximum charging level: 100%

Getting Started

To set smart charging mode, go to **Settings**  > **Battery**  > **Smart Charging** or **EmKit**  > **EmSettings**  > **Smart Charging**.

Figure 11 Smart charging



Find detail information of each mode in **Detail** and select the desired mode.

Getting Started

Charge with power adapter

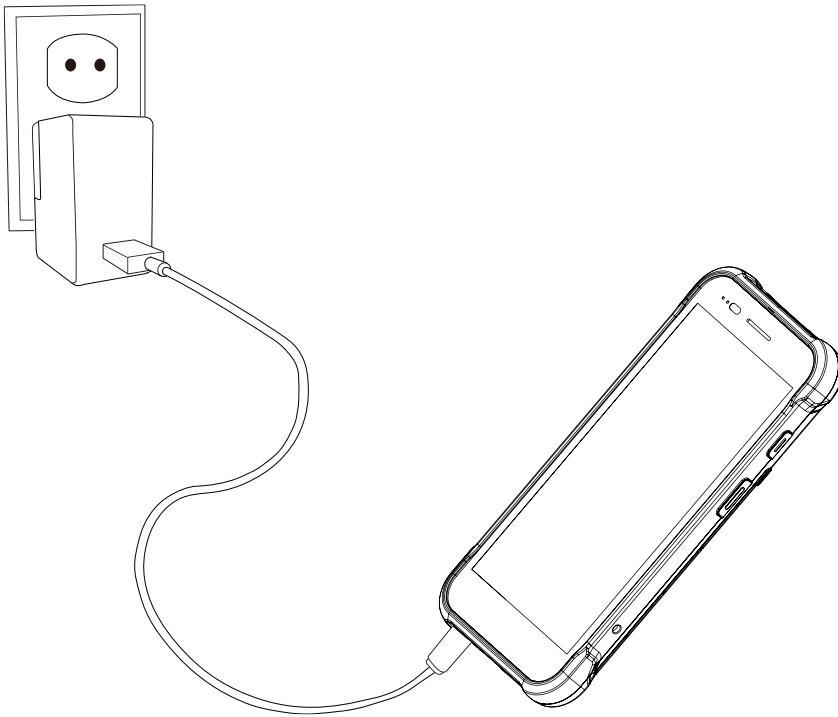


Caution: Always use an original charger and cable from Point Mobile. Other chargers and cables may damage the device. Also, make sure the charger and cables are not wet. Follow the [battery safety information](#) for safety of using the battery.

1. Assemble the country plug, AC/DC power supply and USB type C cable.
2. Connect the cable to the USB connector of PM75.
3. Provide power by plugging the power supply to the wall socket.

When charging starts properly, a battery charging icon is displayed on the status bar, and power LED lights up. (Red – charging / Green – fully charged)

Figure 12 Charging PM75 with power adapter



Getting Started

Charging Cradle

PM75 can be charged with a dedicated charging cradle (Sold separately). Supported charging cradles are SSC (Single Slot Cradle), 2SC (2 Slot Cradle), and 4SBC (4 Slot Battery Cradle).

SSC (Single Slot Cradle)

SSC has one device charging slot and one battery charging slot. It can charge the device as below.

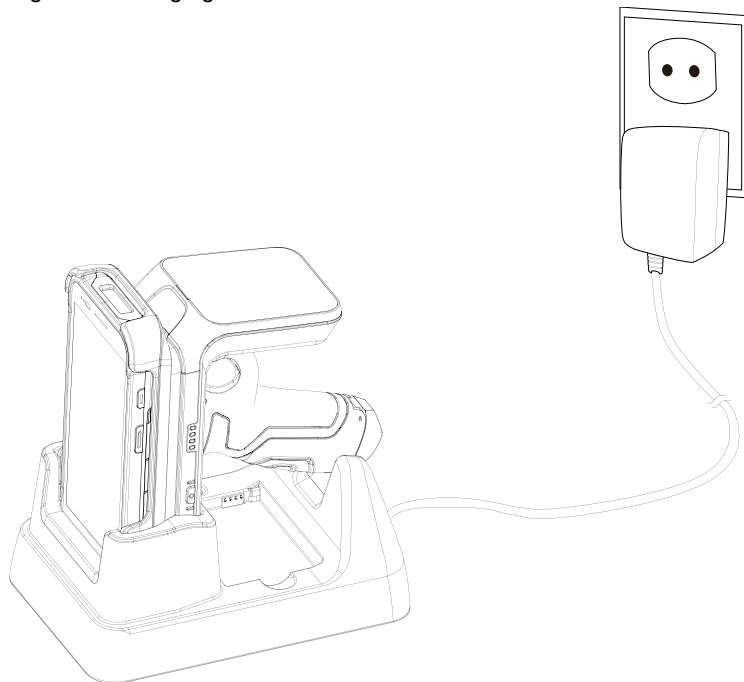
- PM75 only
- PM75 + sled accessory (gun handle or RF750) mounted

To charge device and battery using SSC,

1. Assemble the power adapter and AC plug, and connect it to the cradle to provide power.
2. Install PM75 only or PM75 with sled type accessory mounted.

Make sure the charging LEDs of the PM75 light up, and a charging icon is displayed on the status bar.

Figure 13 Charging PM75 + RF750 via SSC



Note: Charging PM75 + RF750

When putting the PM75 with RF750 mounted onto the cradle, the devices will be charged simultaneously. So, make sure the charging LED of the RF750 lights on, too. (Refer to RF750 User Manual or Quick Start Guide).

Getting Started

2SC (2 Slot Cradle)

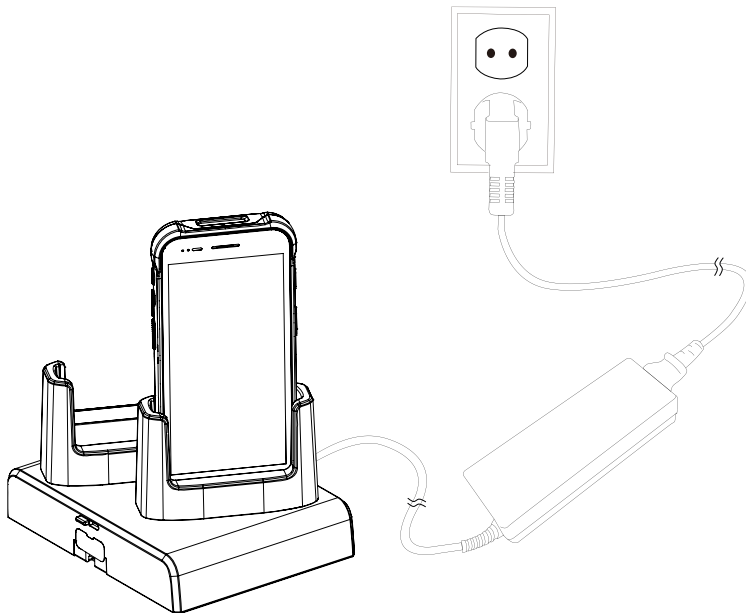
2SC has two device charging slots. With 2SC, up to 2 units of PM75 with no accessories attached can be charged simultaneously.

To charge the devices via 2SC,

1. Assemble the power adapter and power cable.
2. Connect it to the cradle to provide power.
3. Install PM75 from top to bottom as the cradle charging connector on PM75 is facing down.

Make sure the charging LED of the PM75 lights on and a charging icon is displayed on the status bar.

Figure 14 Charging PM75 via 2SC



Note: Share Cradle

Up to 3 pcs of 2SC can be assembled to make share cradle. The cradle can be 2SC (one piece), 4SC (assemble two pieces), and 6SC (assemble three pieces) so that you can charge more devices at the same time.

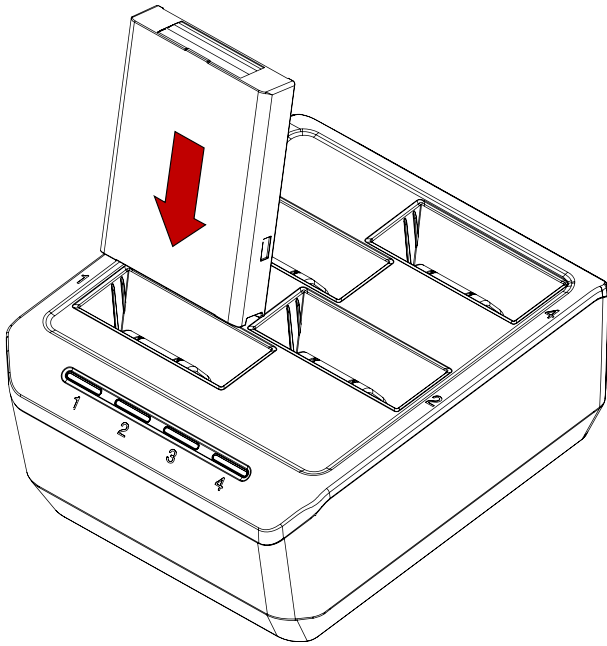
Getting Started

4SBC (4 Slot Battery Cradle)

4SBC has four battery charging slots so it can charge up to 4 batteries at the same time. 4SBC is common for PM85 and PM75 batteries.

Insert the battery into the slot, and make sure that the LED indicator lights on (can recognize with slot number).

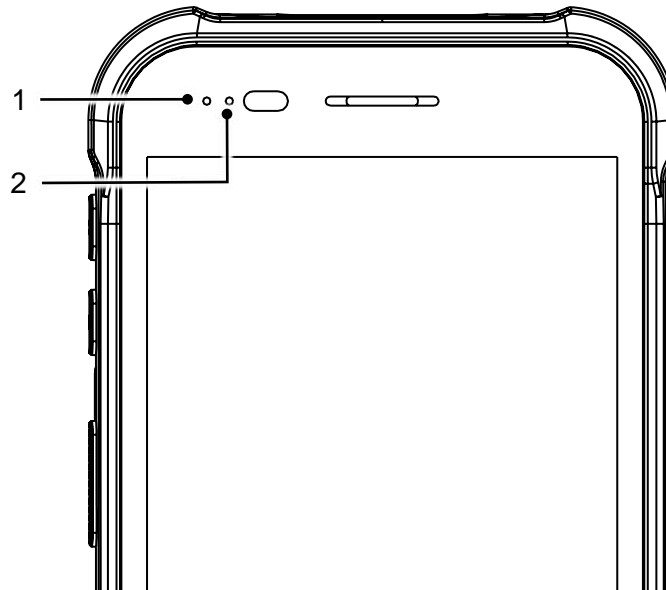
Figure 15 Charging battery via 4SBC











Getting Started

LED Indicator

Figure 16 LED indicators



No	Indicator	Status	Indication
1	Power LED	 Solid green	Device is fully charged
		 Solid red	Device is charging (With charger) / Battery is low (Without charger)
		 Blinking red	Charging temperature is too low or too high (With charger) / Battery is very low (Without charger)
		 Alternately blinking red & green	Cannot recognize the battery
2	Notification LED	 Solid red	Device entered hot swap mode
		 Blinking blue	Notification existing
		 Blue flash	Barcode reading success
		 Red flash	Barcode reading failed

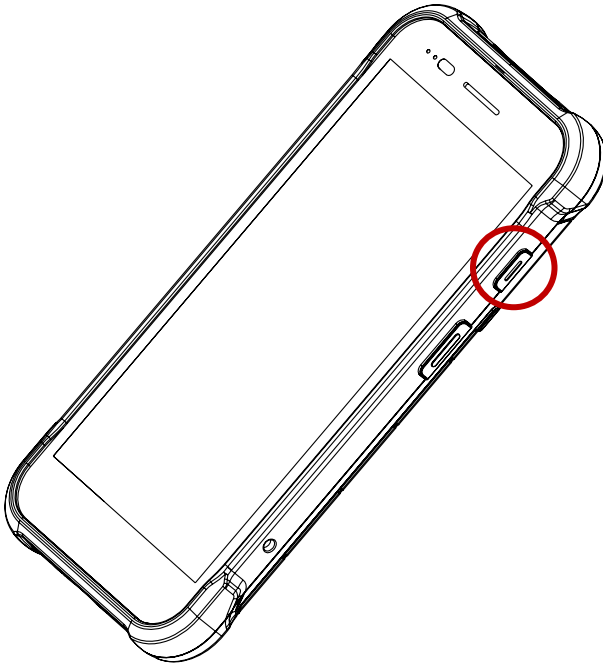
Getting Started

Turn on & off PM75

To turn on the device,

- Press and hold the **power** button on the right side of the PM75 until **SMART BEYOND RUGGED** logo displays on the screen.

Figure 17 Power button

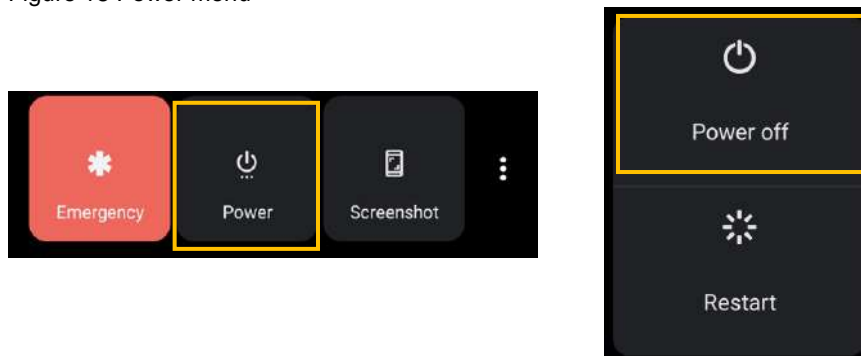


To turn off the device,

- Press and hold the **power** button when the screen is on, until the power menu is shown.

Then, tap **Power** > **Power off** among the menu.

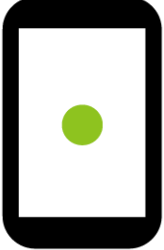
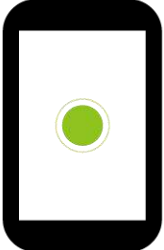
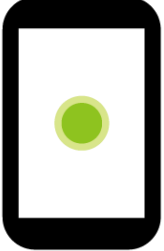
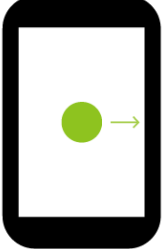
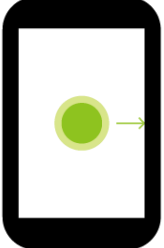
Figure 18 Power menu



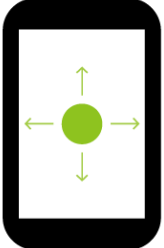
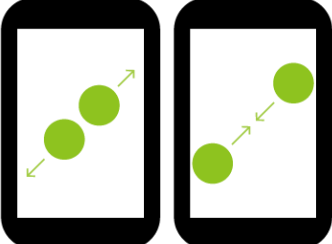
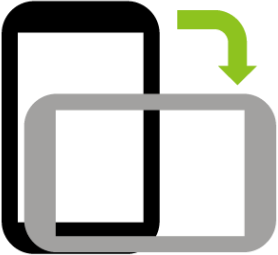
Getting Started

Use a Touch Screen

Controlling the touch screen

Gesture	Description
	<p>Tap One-finger press</p>
	<p>Double tap One-finger press, lift, one-finger press, lift for zoom in action</p>
	<p>Long-press One-finger press, wait, lift for select action</p>
	<p>Drag, Swipe, or Fling One-finger press, move, lift for scroll or tilt action</p>
	<p>Long-press drag One-finger press, wait, move, lift for pick up and move, or select multiple items action</p>

Getting Started

Action	Description
	<p>Scroll Vertical or horizontal swipe in a single direction</p>
	<p>Pinch Open & Close Two-finger press, move outwards and inwards, lift for zoom in / out action</p>
	<p>Rotate When PM30 is turning sideways, screen orientation is changing</p>

Getting Started

System navigation

Navigation bar (Software Button)

The navigation bar is enabled as a default, and it is located at the bottom of the screen. The app overview button, home button, and back button are placed on the bar in order.

Figure 19 Navigation bar





Shape	Button	Function
■	App overview button	Tap to see the recently used app list.
●	Home button	Tap to go to home screen. Long-press to launch the Google Assistant.
◀	Back button	Tap to go back to previous screen.

Getting Started

Gesture Navigation

If you are unfamiliar with the navigation bar or you want to see the screen with a wider screen, hide the navigation bar. The functions provided by the software buttons on the navigation bar can be used by using specific gestures.

To hide the navigation bar, navigate to **Setting**  > **System**  > **Gesture** > **System navigation** and change the setting to **Gesture navigation**. Then, the navigation bar will be hidden.


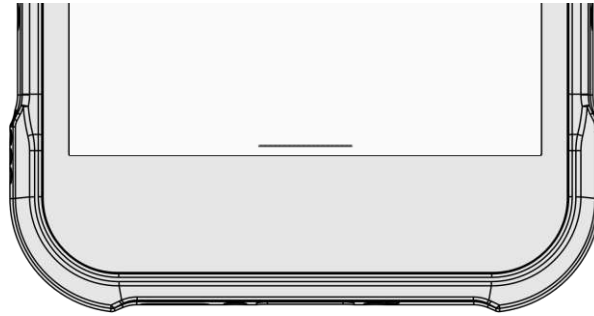
 **Note:** To use the navigation bar again, change the setting to **3-button navigation**.

Figure 20 Gesture navigation



Find the gestures and matched function in the table below.

Function	Gesture
Open app overview	Swipe up from the bottom of the screen, hold, then release.
Go to home screen	Swipe up from the center-bottom of the screen.
Back to previous screen	Swipe from the left or right edge of the screen.
Launch Google Assistant	Swipe up from either the left-bottom or right-bottom.

Learning the Basics

Setup Wizard

When PM75 starts very first time or boot after factory reset, Setup wizard is launched. Following the steps on the screen, set system language, Google account, Wi-Fi connection and copy the data, etc. Some settings can be skipped, but there may be restrictions on the use of system.

Figure 22 Setup wizard - main screen

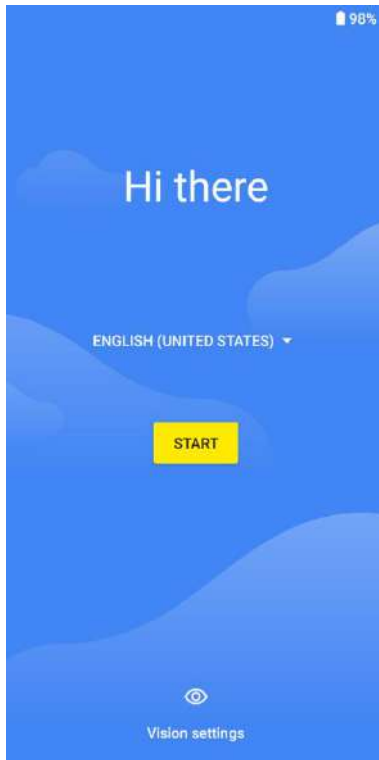
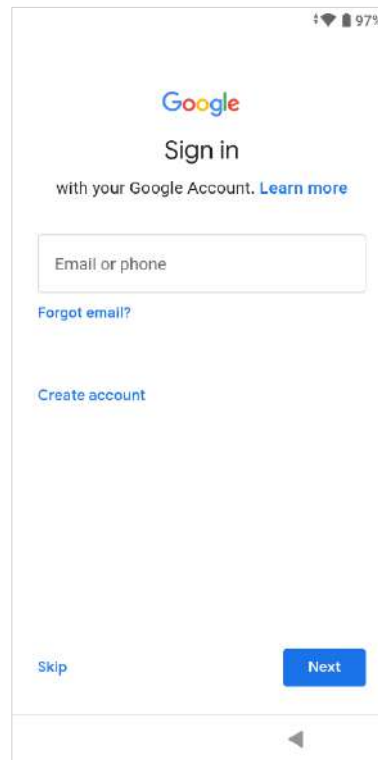


Figure 21 Setup wizard - Google account

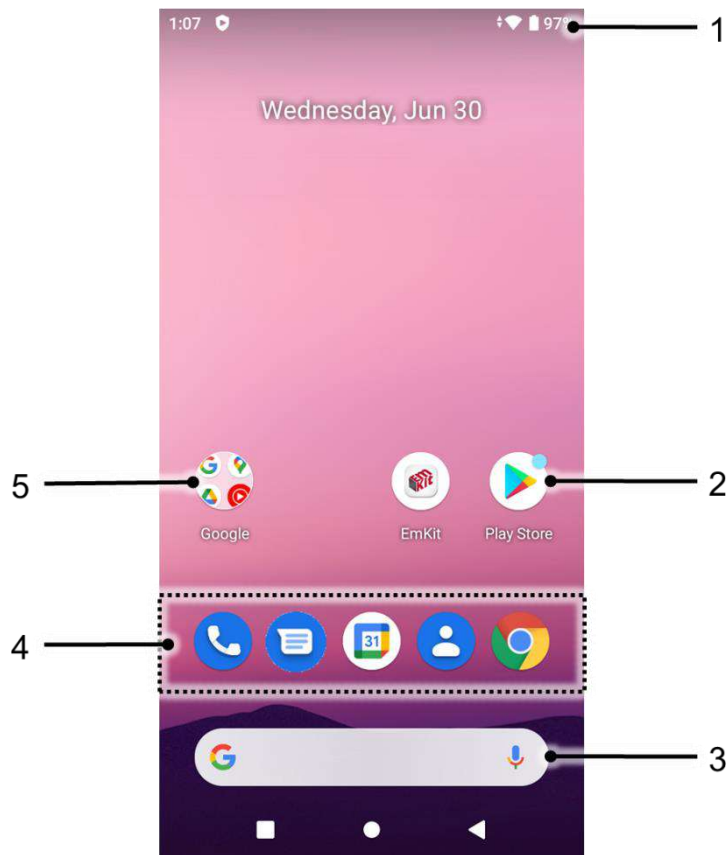


Learning the Basics

Home Screen

Home screen is a screen displayed after Setup wizard or pressing the Home button.

Figure 23 Home screen






























No	Item	Description
1	Status bar	Indicates device status and notification.
2	App	Tap to run the application Long-press to see the application's options
3	Google search	Search an item with Google
4	Favorites tray	Place the frequently used apps
5	App folder	Apps are organized in the folder. Tap to open the App folder

Learning the Basics

Status bar












Time, status icons, and notification icons are on the Status bar.

Status icons

Icon	Description	Icon	Description
	LTE connected		Strong signal
	3G connected		Weak signal
	EDGE connected		Connection issue
	LTE+ (LTE CA) connected		Data disabled
	VoLTE enabled		No data connection
	Airplane mode		Hotspot enabled
	Connected to a Wi-Fi network		Wi-Fi data communication
	Connected to a Bluetooth device		
	Battery is full		Battery is partially drained
	Battery is low		Battery is critical low
	Battery is charging		Cannot recognize battery
	Location service turned on		Vibrate mode
	Speakerphone turned on		Phone mic is mute
	Scanner turned on		Scanner turned on, but trigger turned off
	Alarm is set		

Learning the Basics

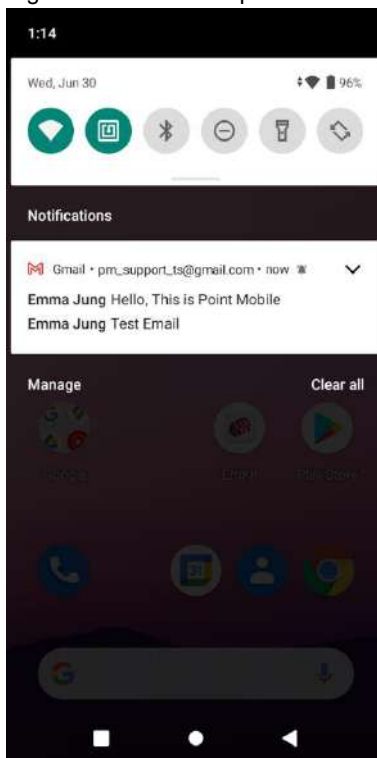
Notification icons

Icon	Description	Icon	Description
	Missed call		New SMS or MMS message
	New Email		Connected to VPN network
	Upcoming event		Other input method available
	File uploaded		File downloaded
	File copied		OTG device connected
	There are more notifications		

Notification panel

Notification panel displays a list of all notifications. Tap a notification to respond. To open the Notification panel, drag the Status bar down. To close the panel, swipe it up.

Figure 24 Notification panel



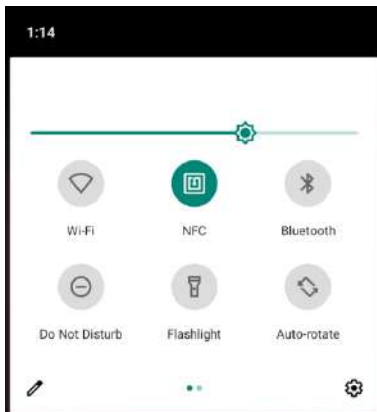
Learning the Basics

Quick setting panel


Quick setting panel contains some frequently used settings such as Wi-Fi, Bluetooth, etc. To use the Quick setting panel,

1. Open the Notification panel.
2. Drag down the Notification panel.
3. Tap a setting icon to enable / disable the setting or long-press an icon to see more detail.

Figure 25 Quick setting panel



To edit the configuration of Quick settings panel,

1. Tap  on the bottom of the panel.
2. By long-press and dragging the icon, customize the configuration of the panel.

Learning the Basics

Apps & Widget

App folder

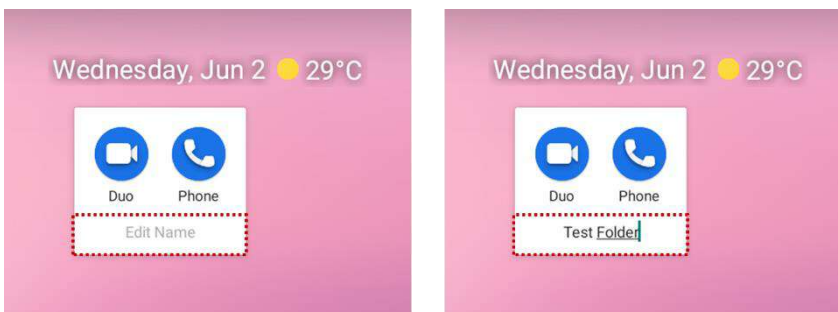
To create the app folder, long-press an app icon and drag it to another app icon.

Figure 26 Create app folder



To change the folder name, tap the **Unnamed Folder** and input a new name.

Figure 27 Change app folder name



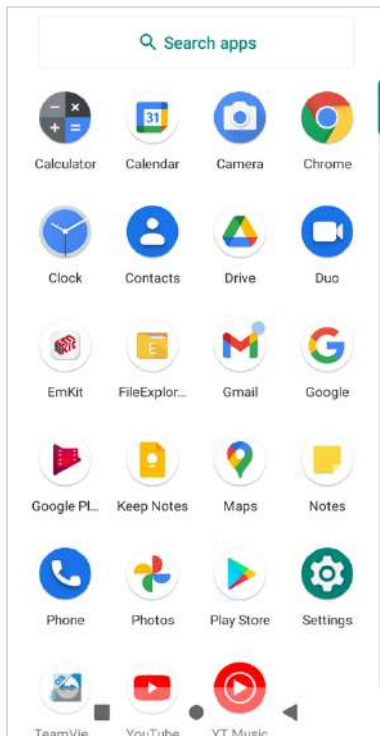
Learning the Basics

App drawer

All installed apps are listed alphabetically in App drawer.

- To open the App drawer, swipe up the Home screen.
- To close the App drawer, swipe down the Home screen.

Figure 28 App drawer



Favorites tray

To organize an app in the Favorites tray,

1. Long-press an app icon from the App drawer. Then, drag it slightly until the Home screen is shown.
2. Place the app icon in the Favorites tray.

Figure 29 Add an app to Favorites tray



Learning the Basics

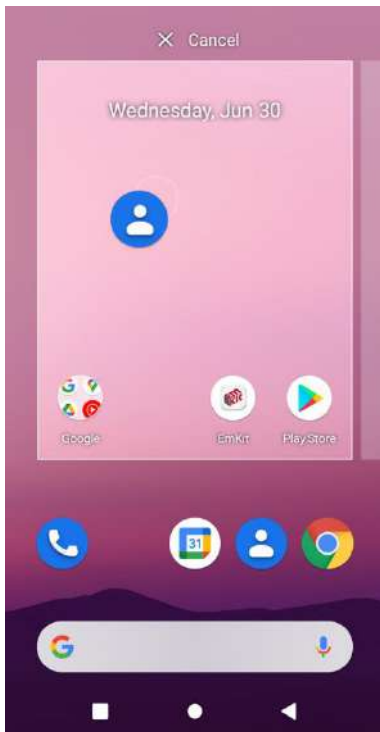
Organize app in Home screen

To organize an app in the Home screen,

1. Long-press an app icon from the App drawer. Then, drag it slightly until the Home screen is shown.
2. Place the app icon where you want.

(To cancel to place the app, drag it to **Cancel** area and release.)

Figure 30 Place app in Home screen



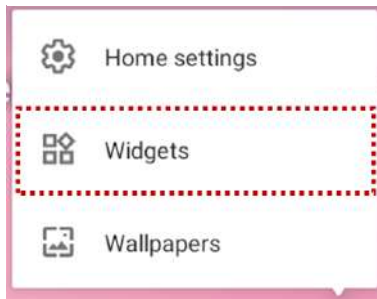
Learning the Basics

Widget

To add a widget in the Home screen,

1. Long-press the empty space of the Home screen.
2. In three menus, select **Widgets**.

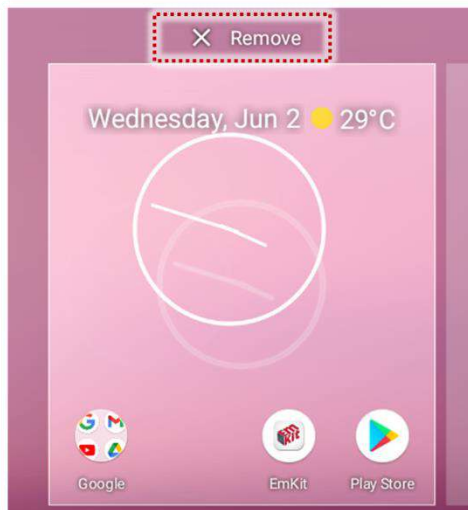
Figure 31 Widget menus



3. Among the list, tap and hold a widget you want to add.
4. Place the widget to the Home screen by dragging.

i **Note:** To remove an app or a widget from the Home screen, long-press and drag it to **Remove** area.

Figure 32 Remove from Home screen



Learning the Basics

Call

i **Note:** Calling is only available on LTE SKU (SKU4 ~ 7).

To make or receive a phone call, SIM card is required. Insert SIM card to PM75 first regarding [Install SIM & SD card](#).

Making a call



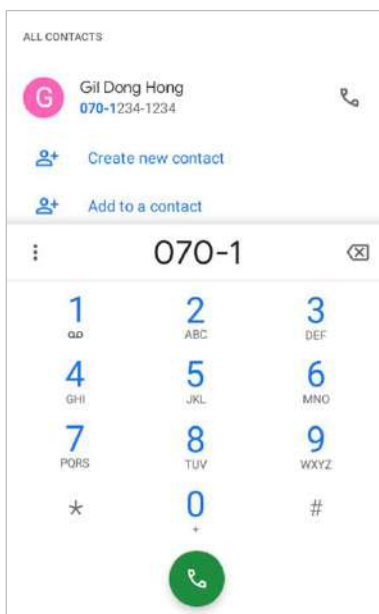


1. Tap **Phone**  from Home screen or App drawer.
2. Tap  to open a dialer.
3. Input a phone number.

Figure 33 Dialer







4. Tap  or  next to a searched number to make a call.

Learning the Basics

5. Control the Tap  to hang up the phone.

Figure 34 Calling screen



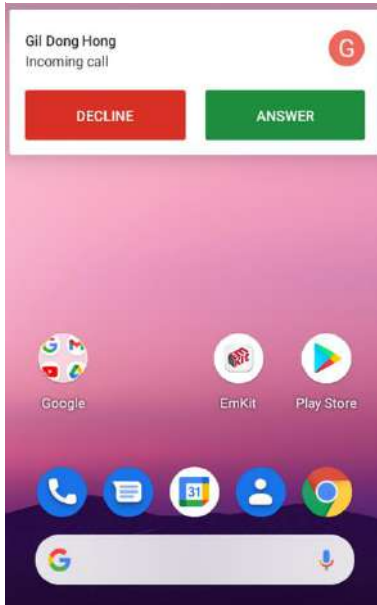
Icon	Function Name	Description
	Mute	Mute microphone
	Keypad	Open the keypad
	Speaker	Speakerphone mode
	Add call	Add another call (Enable when receiver answer the phone)

Learning the Basics

Answering a call

Check the caller's name and number and tap **ANSWER** button to answer the phone call. Or tap **DECLINE** button to decline the phone call.

Figure 35 Receiving call



Learning the Basics

Contacts

Add a contact

Add a contact via dialer

1. Navigate to dialer through Phone, and enter the number.
2. Tap **Create new contact** or **Add to a contact** to save the number.
3. Input additional information.
4. Tap **Save**.

Add a contact via contacts app



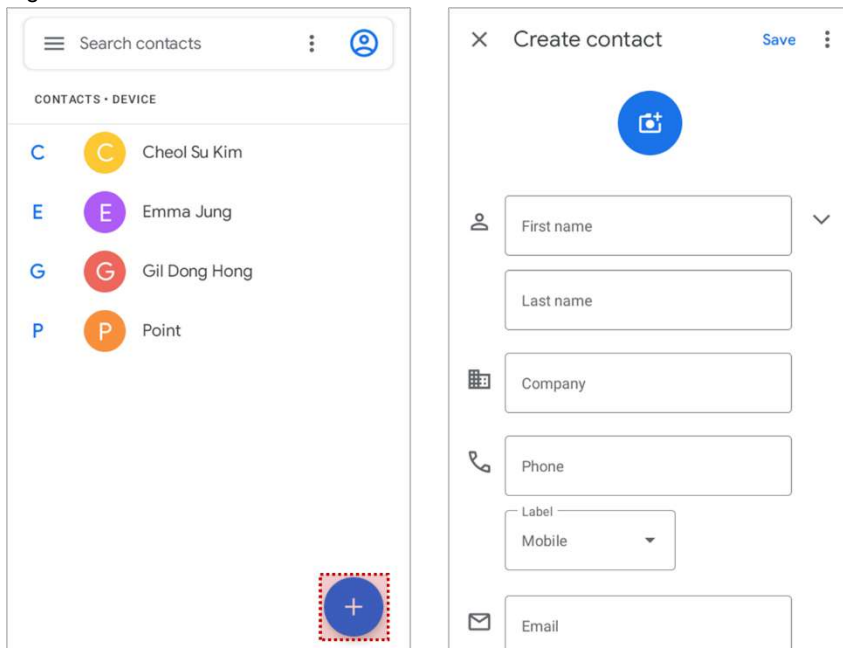
Navigate to **Contacts**  from App drawer and tap  to add a new contact.

Figure 36 Add new contact via Contacts



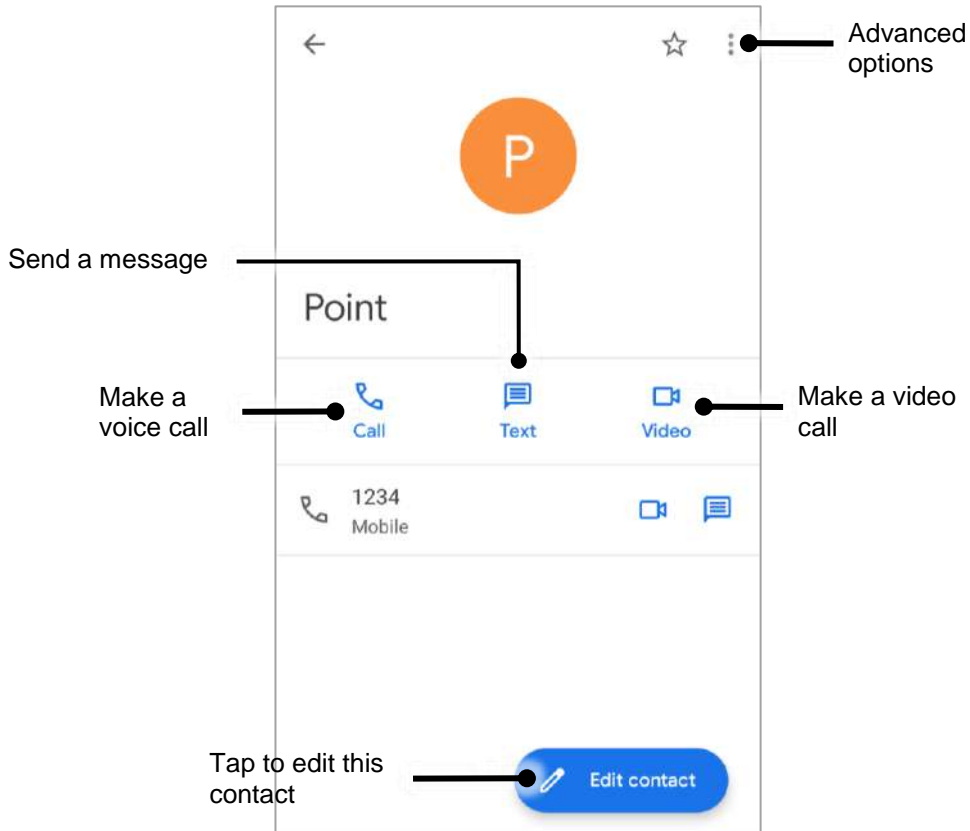
Enter the contact details and tap **Save**.

Learning the Basics

Contact detail

Select a contact from the list to find more detail information.

Figure 37 Contact detail




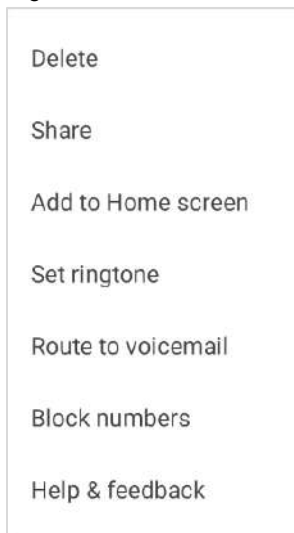
Tap  to open advanced options such as delete, share, block, etc.


Figure 38 Contact advanced options



Learning the Basics

Message

i **Note:** Message feature is only available on LTE SKU (SKU4 ~ 7). And it requires a SIM card.

Send a message or find the received message through Message application .


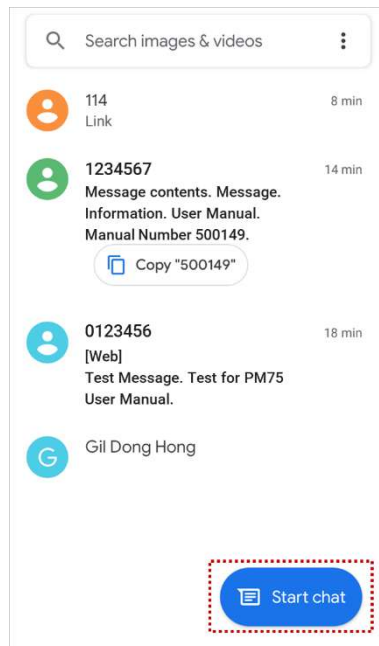

1. Launch **Message**  from App drawer.
2. Tap **Start Chat** and type the receiver's name or phone number.

Figure 39 Message list



3. Input a message.
4. Tap  icon to send.

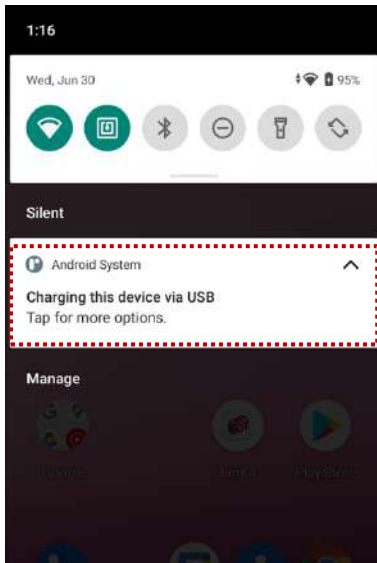
Learning the Basics

MTP Connection with PC

To transfer the files with a PC, connect the device to the PC via USB cable first.

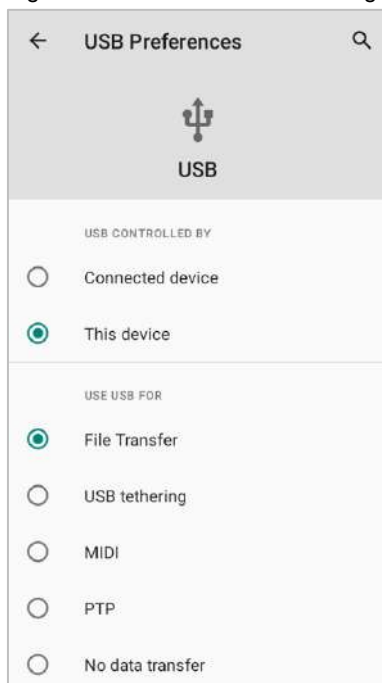
1. Drag down Status bar and tap **Android System** notification to change USB preference option.

Figure 40 USB connection notification



2. Change the option to **File Transfer** from **No data transfer**.

Figure 41 USB Preferences setting



Learning the Basics

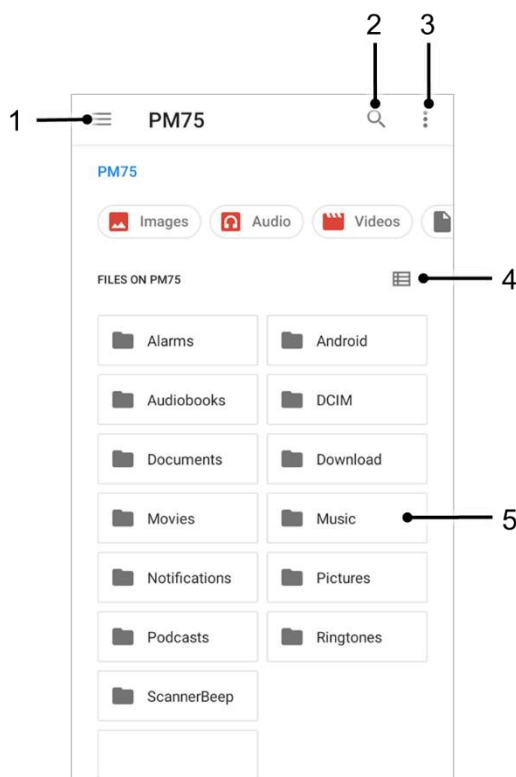
3. Now PC can recognize the connected device. Find PM75 device from file explorer of the PC.

Figure 42 File explorer on PC



Manage the Files

Figure 43 FileExplorer main screen

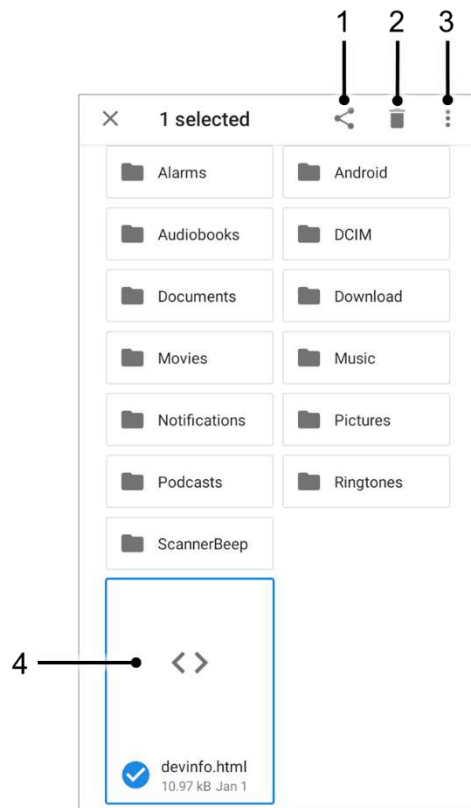


No	Description
1	Select media file type or storage
2	Search a file
3	Open the advanced option – Create a new window or folder, Select all files and folders, etc.
4	Change the view of file list
5	Tap a file or folder to open. Or long-press a file or folder to select

Learning the Basics

Long-press a file (folder) or tap the icon which is located beside of file name to select the file (folder).

Figure 44 FileExplorer screen when file selected



No	Description
1	Share the file via Bluetooth / Gmail / Google Drive, etc. Sharing is possible only with files
2	Delete the files or folders
3	Open the advanced option <ul style="list-style-type: none"> - Open with: Select which app to open the file - Sort by...: Sort the list by file name, size, type, etc. - Select all: Select all files and folders - Copy / Move to: Copy or move the file to a new location - Compress: Create Zip file with the selected files or folders - Rename: Rename the file or folder - Get info: Display the file information
4	Selected file or folder is highlighted

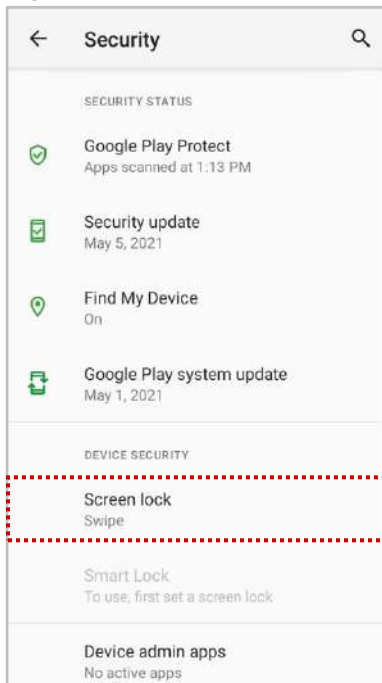
Learning the Basics

Lock the Screen

Protect the device from unauthorized personnel by setting up the screen lock.

1. Navigate to **Settings**  > **Security** .
2. Tap **Screen lock**.

Figure 45 Screen lock





3. Choose a screen lock method.
 - None: Screen unlocks immediately
 - Swipe: Swipe the lock screen to unlock (Default)
 - Pattern: Draw a pattern to unlock
 - PIN: Input a PIN to unlock (At least 4 digits)
 - Password: Input a password to unlock (At least 4 characters)

Learning the Basics

Settings

There are two ways to go to **Settings**:

- Open the App drawer and tap **Settings** 
- Open the Quick setting panel and tap gear icon 

Adjust display brightness

To adjust the display brightness level,



- Open Quick setting panel and adjust display brightness bar
- Go to **Settings**  > **Display**  > **Brightness level**

Figure 46 Normal brightness level



Figure 47 High brightness level (higher than 80%)



Caution: Using high brightness levels for long periods may cause eye strain and increase battery consumption.

Adjust sound


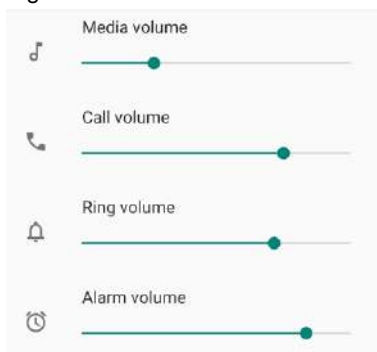
To adjust sound volume, go to **Settings**  > **Sound**  and control the Media, Call, Ring, Alarm volume bars.

Figure 48 Volume bars



Caution: Using high volume levels for long periods may cause ear strain and increase battery consumption.

Learning the Basics

Adjust font size

If the font size of the screen is too small or too large, adjust the font size.



1. Go to **Settings**  > **Display** 
2. Tap **Advanced**
3. Tap **Font size**
4. Referring to the **Preview**, set the font size

Figure 49 Set font size



Using the Buttons

Screenshot

To take a screenshot, use one of the two ways as below.

- Press and hold the power button and volume down button simultaneously.
- Press and hold the power button, and then tap **Screenshot** among the power menus.

The screenshot image will be saved to **Pictures > Screenshots** folder in the internal storage.

Program Buttons

All buttons on the PM75 except power button can be optimized as you want. To map the button to other functions from default,



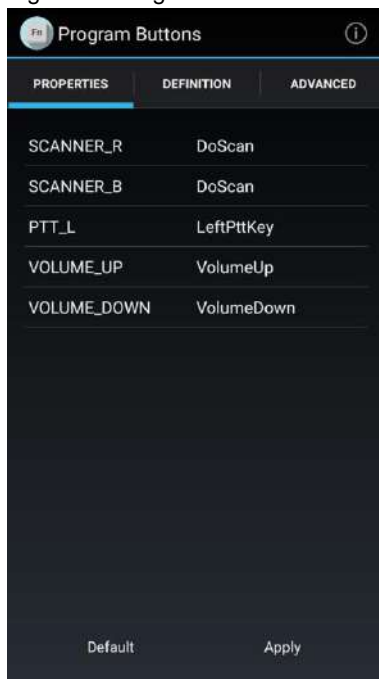
1. Navigate to **EmKit**  > **Program Buttons** 
2. Select a button from the list

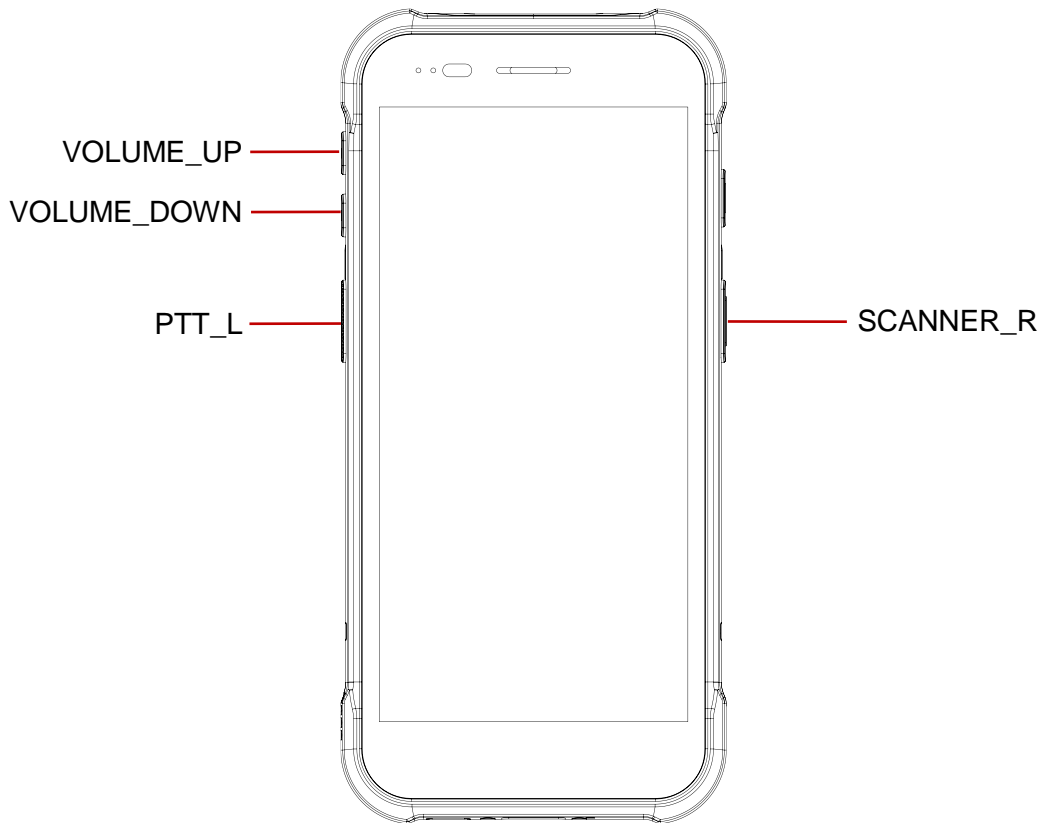
Figure 50 Program buttons - button list



Refer to the figure indicating button code name in the next page.

Using the Buttons

Figure 51 PM75 button code name



i **Note:**

- **SCANNER_B:** Trigger button on the gun handle.

3. Choose one function you want to remap
4. Tap **OK**
5. After changing all key mapping, tap **Apply** to save the changes

Camera


PM75 has rear camera. To use the camera, open App drawer and tap Camera application .

Figure 52 is a main screen of Camera application, and Figure 53 is a screen that is displayed when you swipe the screen to right.

Figure 52 Camera main screen

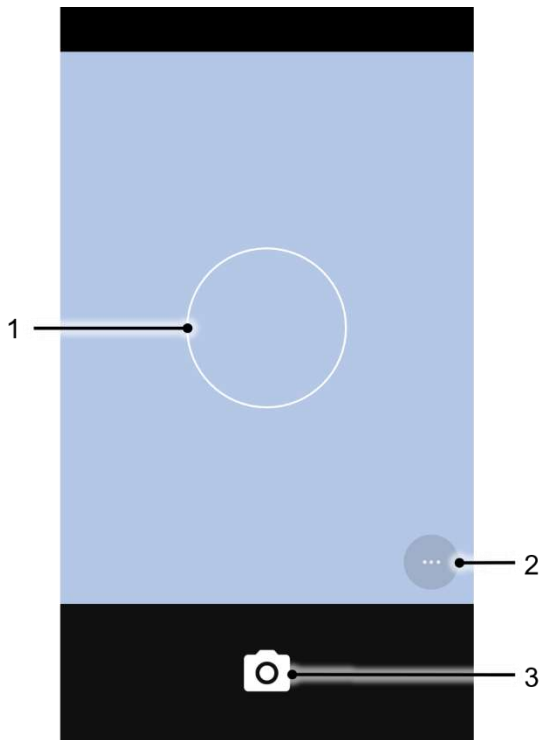
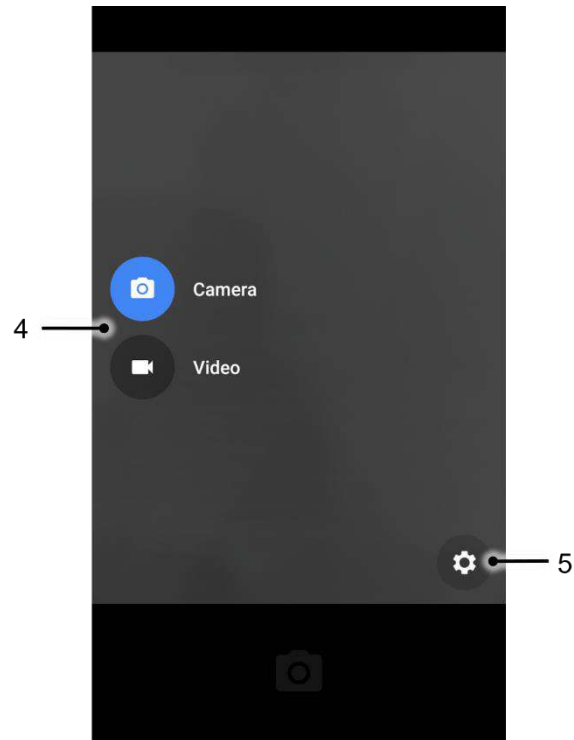





Figure 53 Camera mode change/setting screen

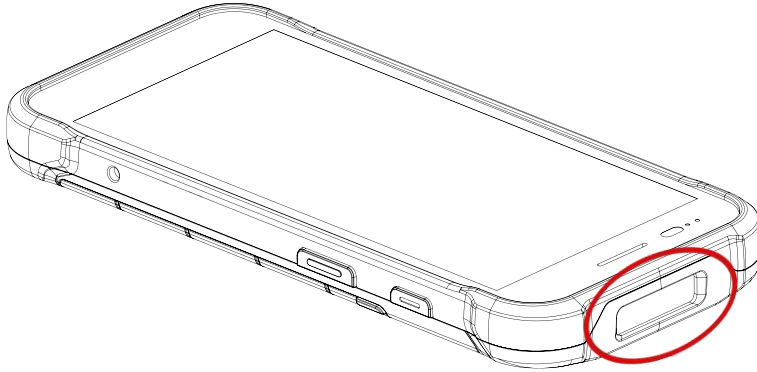


No	Name	Description
1	Focus zone	You can change the focusing area by touching the other area
2	Advanced camera option	 : Set timer  : Display the grid on the screen  : Set flash mode (Activate / Deactivate / Auto mode)
3	Shutter button	Take a picture or recode a video
4	Mode change button	Change the Camera or Video mode
5	Advanced camera setting	Set resolution & quality of picture Enable / Disable saving location and manual exposure

Scanner



Scanner is placed on the top of the PM75. Optimize the scanner settings for working environment and improve the efficiency.

Figure 54 PM75 scanner location



Turn on / off the Scanner

The scanner is turned off by default. To turn on the scanner, follow the steps.

1. Go to **EmKit**  or **Settings**  and tap **ScanSettings**.
2. Tap toggle button to turn on/off the barcode scanner.


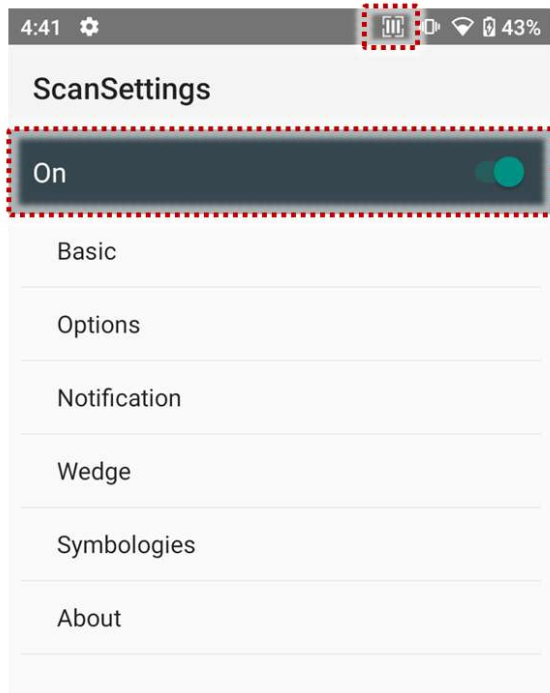
Check if the scanner icon () is placed on Status b

Figure 55 Turn on scanner



Scanner

ScanSettings

When the scanner is turned on, scanner setting menus will be displayed. **ScanSettings** consists of

- Basic
- Options
- Notification
- Wedge
- Symbologies
- About

Basic

Control the scanning options and wedge mode options.

1. Scanning

- Change the scanner's trigger timeout and set Auto scan & Continuous scan.
- Enable or disable the TouchScan, which is a software scanner button. Place a scan icon in any position and tap the icon to read a barcode.

Figure 57 ScanSettings - Basic

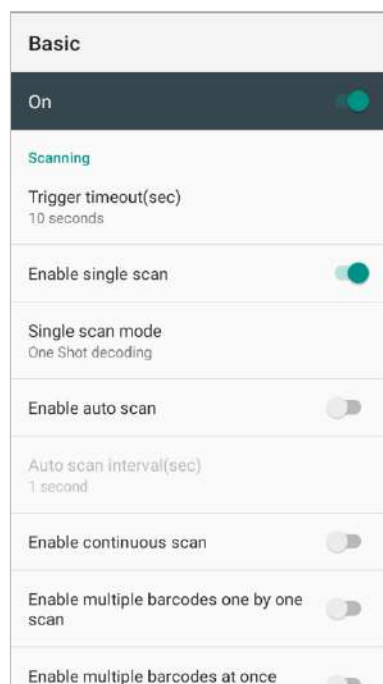
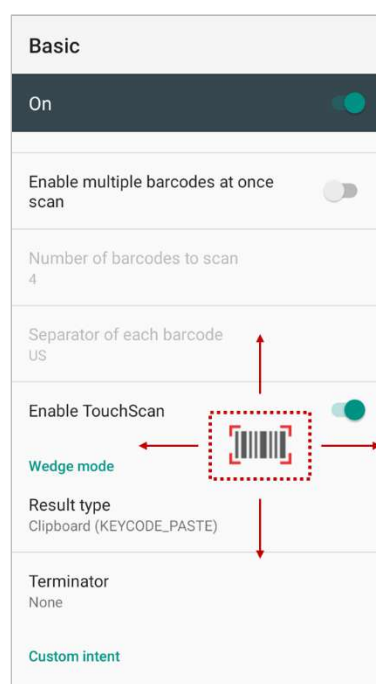


Figure 56 ScanSettings - TouchScan



Scanner

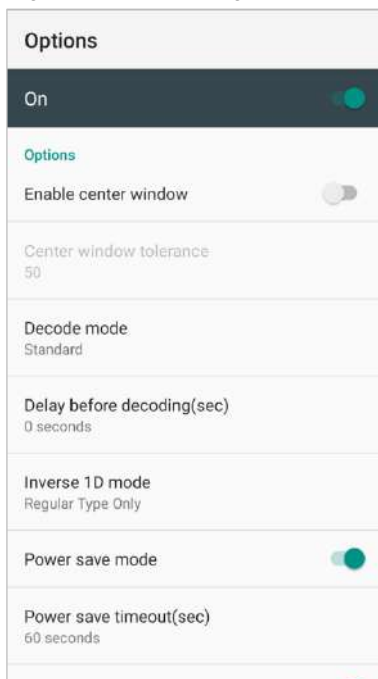
2. Wedge mode

- Change the result type of decoded data among the below list.
 - User Message
 - Keyboard Event
 - Clipboard (KEYCODE_PASTE)
 - Clipboard (Ctrl + V)
 - Intent Broadcast
 - Custom Intent
- Set Terminator as,
 - None
 - Space
 - Tab
 - LF
 - Tap & LF

Options

- Enable / Disable the center window, Aimer, Illumination.
- Set Decode mode & Power save mode.

Figure 58 ScanSettings - Options

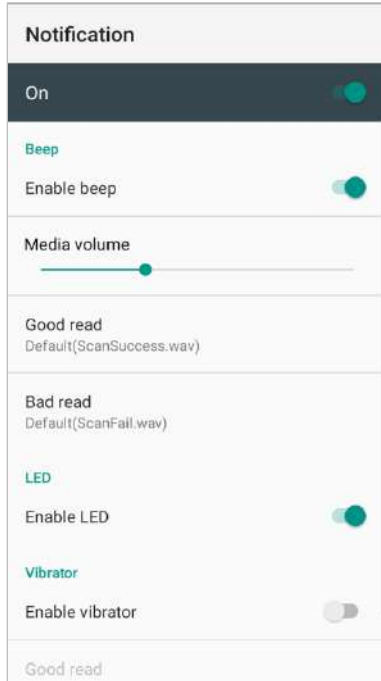


Scanner

Notification

Control the beep sound, LED and vibration option.

Figure 59 ScanSettings - Notification



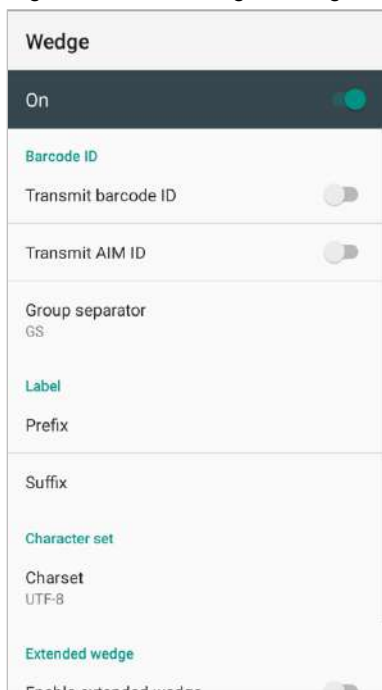
Scanner

Wedge

Set below items in Wedge settings

- Barcode ID
- Aim ID
- Group separator
- Prefix
- Suffix
- Character set
- Extended Wedge

Figure 60 ScanSettings - Wedge



Scanner

Extended wedge

PM75 supports Extended wedge that allows to edit the decoded data. Tap **Enable extended wedge** toggle switch and then set a rule in **Configuration extended wedge**.

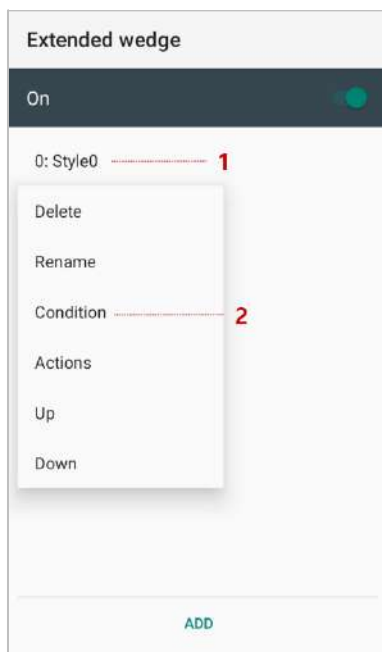
Figure 61 ScanSettings - Extended wedge



For example, make a rule that add a string “*Point Mobile*” at the start of decoded data whenever decoding CODE128.

1. Tap **Style** (1) and select **Condition** (2).

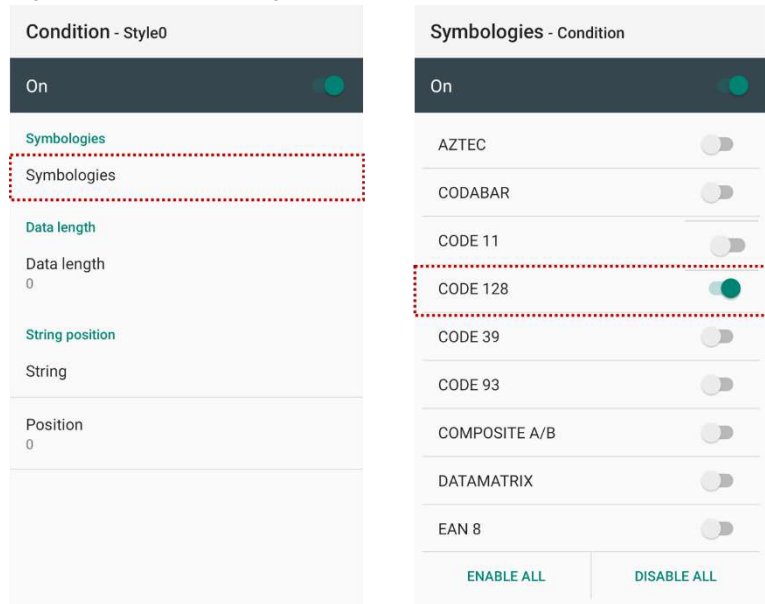
Figure 62 Extended wedge example_1



Scanner

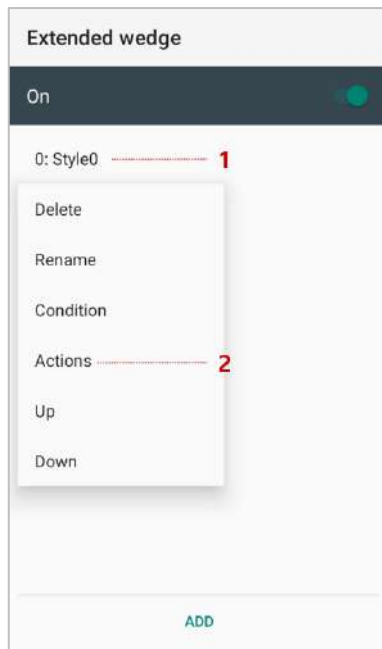
2. Tap **Symbologies** and select **CODE128** among the symbologies.

Figure 63 Extended wedge example_2



3. Tap **Style (1)** and select **Actions (2)**.

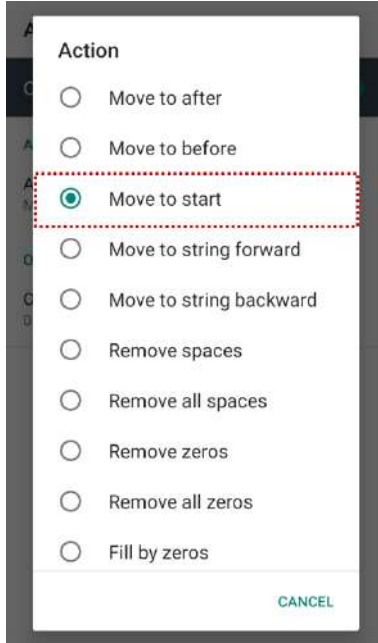
Figure 64 Extended wedge example_3



Scanner

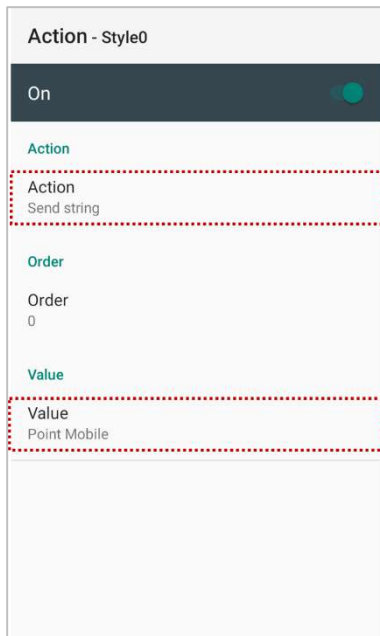
4. Tap **ADD** and select **Move to start** to point the start of the decoded data.

Figure 65 Extended wedge example_4



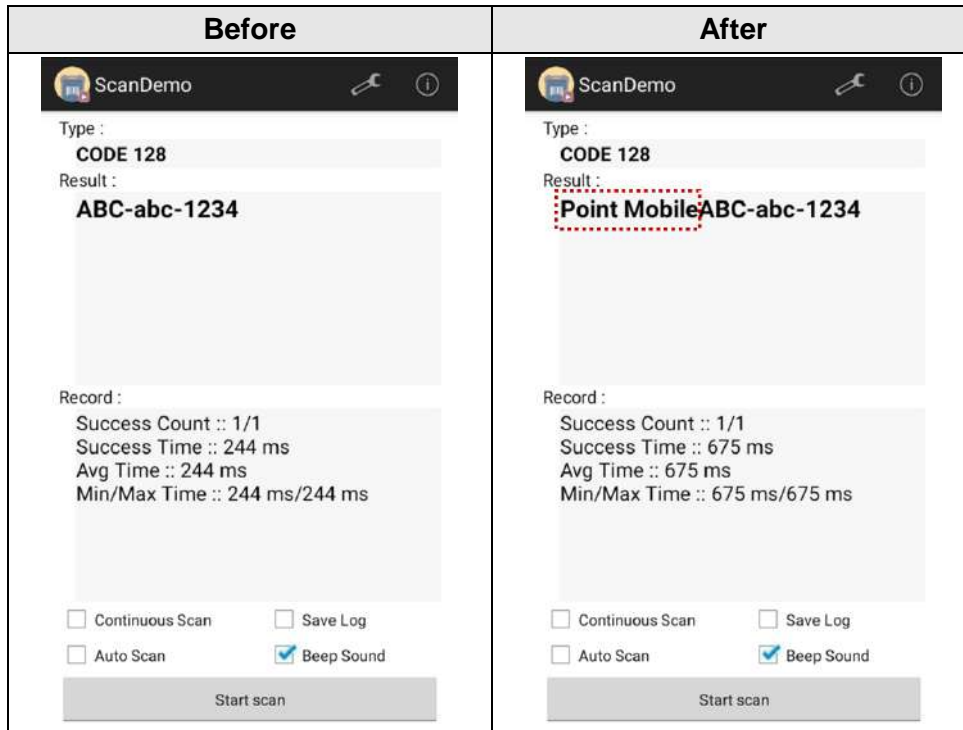
5. Add another action of which action type is Send string. Set value as "*Point Mobile*".

Figure 66 Extended wedge example_5



Scanner

6. "Point Mobile" string will be added to decoded CODE128 data.

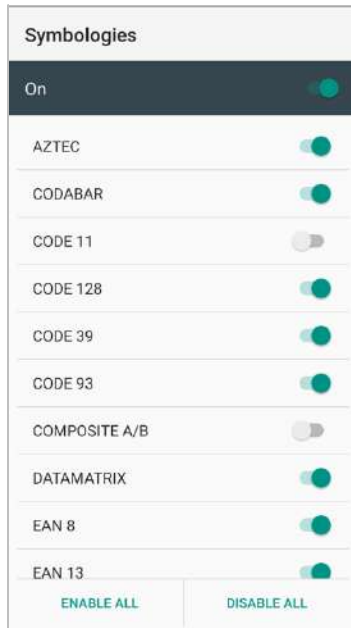


Scanner

Symbologies

Enable or disable the specific symbology or set detail options. By tapping each symbology name to access detail options.

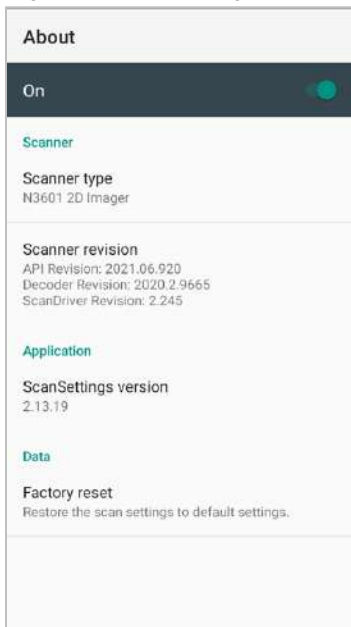
Figure 67 ScanSettings - Symbologies



About

Find the scanner information or restore the scanner settings to default.

Figure 68 ScanSettings - About

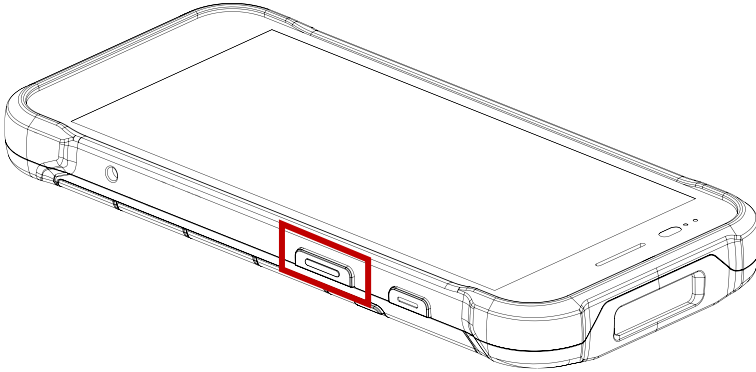


Scanner

Scan a Barcode

Point the scanner at the barcode and press a scan button on the PM75. If another button is set as scan trigger using Program buttons (Refer to [Use the Buttons – Program buttons](#)), it can trigger the scan action, too.

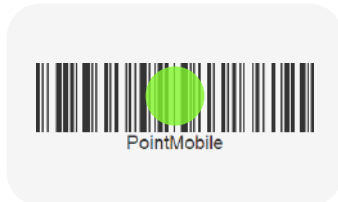
Figure 69 PM75 default scan button



N3601 Scanner SKU

Center the green dot aimer over the barcode. The entire barcode must be inside the illumination square.

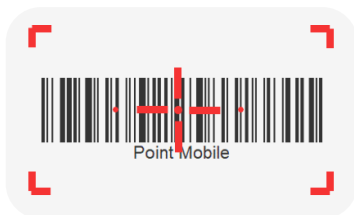
Figure 70 Aiming barcode (N3601)



N6603 Scanner SKU

Center the cross-hair laser aimer over the barcode. The entire barcode must be inside the illumination square.

Figure 71 Aiming barcode (N6603)



Scanner

ScanDemo

Using Scan Demo app, demonstrate the scanning feature.



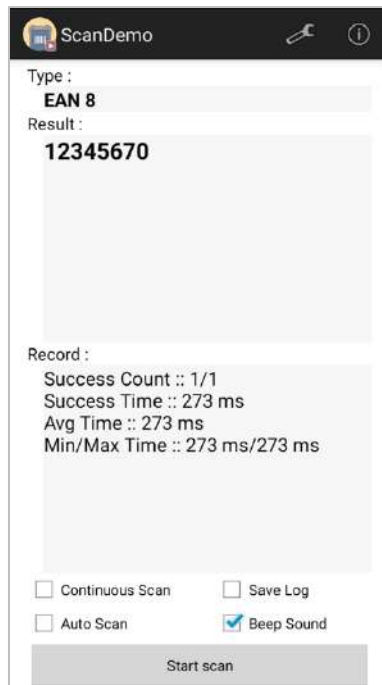
1. Execute **EmKit**  > **ScanDemo** .
2. Scan a barcode by pressing the scan button on the device or tapping **Start scan** button on the screen.
3. Find scan result

Figure 72 ScanDemo



Wireless

Mobile Network

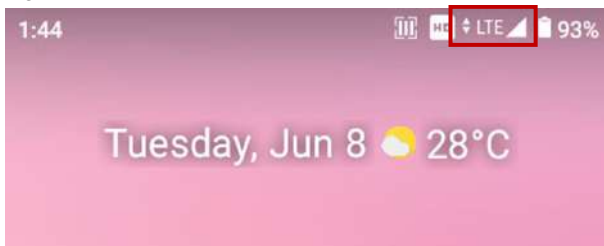


Note: Mobile network is supported on PM75 LTE SKU (SKU 4 ~ 7) only. Check if your PM75 is LTE SKU.

To connect mobile network, SIM card is required. Insert SIM card into PM75 first referring [Install SIM & SD card](#).

After inserting the SIM card, reboot the device. When network is connected, a network icon will be appeared on the status bar.

Figure 73 Mobile network icon



Find network information and adjust the network settings in **Settings** > **Network & internet** . This setting menu can also be accessed by long-press the Mobile data icon in Quick setting panel.

Figure 75 Mobile network setting

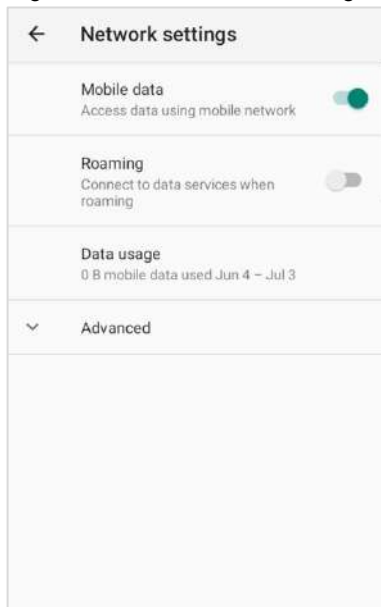
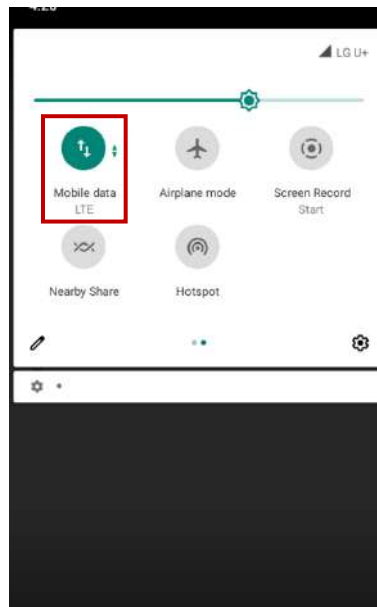


Figure 74 Quick setting panel - mobile network



Wireless

Wi-Fi

To turn on and connect a Wi-Fi,



1. Go to **Settings**  > **Network & internet**  > **Wi-Fi**.
2. Tap toggle button to enable Wi-Fi.
3. Device searches for nearby Wi-Fi signals and lists them in order of signal strength.
4. Select a Wi-Fi SSID to connect.
5. The message **Connected** under the SSID means the device complete to connect to the Wi-Fi.

Figure 76 Wi-Fi connected



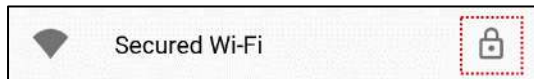
Note: There are Open Wi-Fi network and Secured Wi-Fi network. You can tell those apart by lock icon (🔒) in the nearby Wi-Fi list.

To connect the secured Wi-Fi network, you need to enter the password.

Figure 77 Open Wi-Fi Network

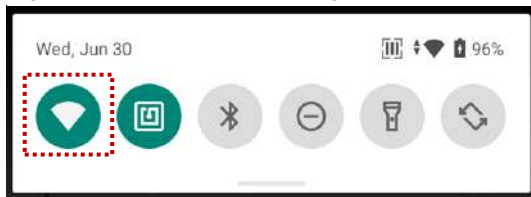


Figure 78 Secured Wi-Fi Network



If there is a saved Wi-Fi network, simply turn on the Wi-Fi through the Quick setting panel. The saved network will be connected automatically.

Figure 79 Wi-Fi in Quick setting panel



Wireless

Bluetooth

Turn on / off

Bluetooth is turned off as default. There are two ways to turn on the Bluetooth,


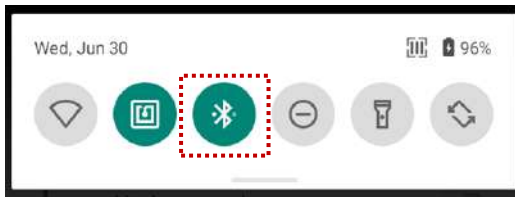
- Open quick setting panel and enable Bluetooth 

Figure 80 Bluetooth in Quick setting panel



- Go to **Settings**  > **Connected devices**  > **Pair new device**

Pair and Connect

Bluetooth is turned off as default. To turn on the Bluetooth and connect with a new device,



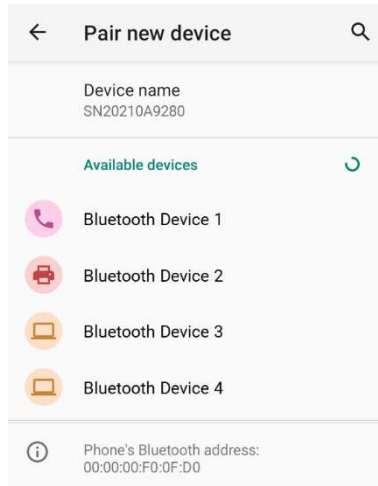
1. Go to **Settings**  > **Connected devices** .
2. Tap **Pair new device**.
(Bluetooth will be turned on automatically)
3. Select the device you want to pair among **Available devices** list.

Figure 81 Bluetooth available devices

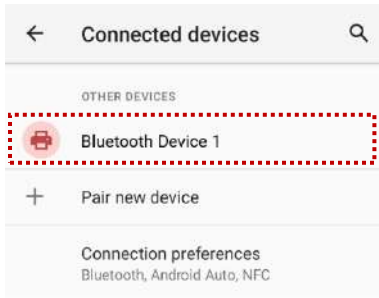


4. Follow instructions on the screen (Pairing code or pairing confirmation dialog) and tap **PAIR**.

Wireless

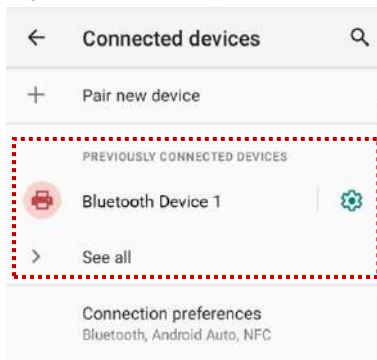
5. When the connection is succeeded, the connected device name is listed in **CURRENTLY CONNECTED**

Figure 82 Bluetooth currently connected




To connect a device previously connected, select the device name from the **PREVIOUSLY CONNECTED DEVICES** list.

Figure 83 Previously connected devices

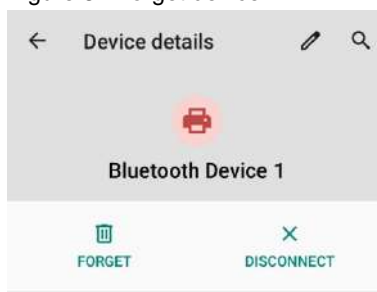


Unpair and Disconnect

To unpair the device, select the name of the device you want to unpair from **CURRENTLY CONNECTED** list and tap **FORGET** .

Or tap **DISCONNECT**  to disconnect only and not unpair.

Figure 84 Forget device



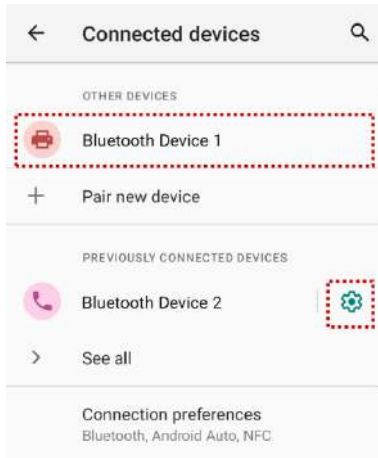
Wireless


Change the Bluetooth device details

Select a device name from **CURRENTLY CONNECTED** or tap  icon next to the device name from **PREVIOUSLY CONNECTED DEVICES** list.

If no devices are listed under the **PREVIOUSLY CONNECTED DEVICES**, tap **See all**.

Figure 85 Bluetooth device detail



- To change the device's name, tap  on the top of the screen
- Turn other settings on or off (Available on some devices)

Wireless

NFC


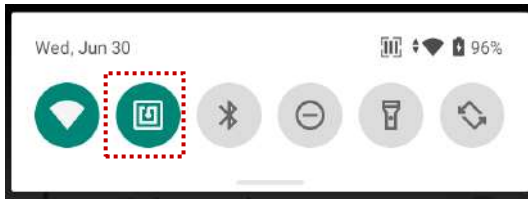
NFC feature is enabled by default. But if NFC does not work, make sure the NFC  is enabled from the Quick setting panel.

Figure 86 Turn on NFC in Quick setting panel



PM75's NFC antenna is located around the battery cover release button. Bring the NFC tag close to the battery cover release button (Rear-upper side of the device) as below.

Figure 87 PM75 NFC tagging area

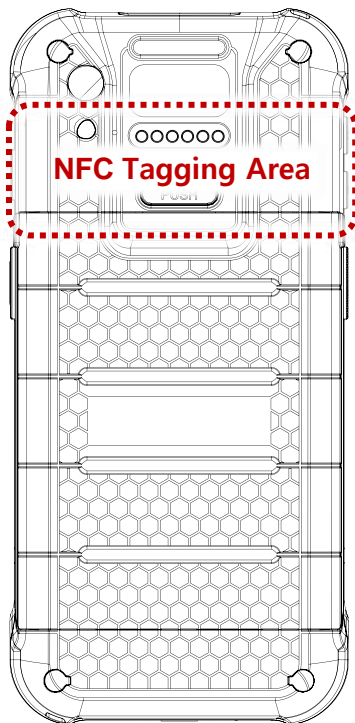


Figure 88 Tagging NFC tag



Wireless

RFID

Connect PM75 to the compatible RFID reader, RF750 (sold separately). In order to connect the devices, RFID Control application is required. Download RFID Control from [Service Portal](#) and install the app on the PM75.

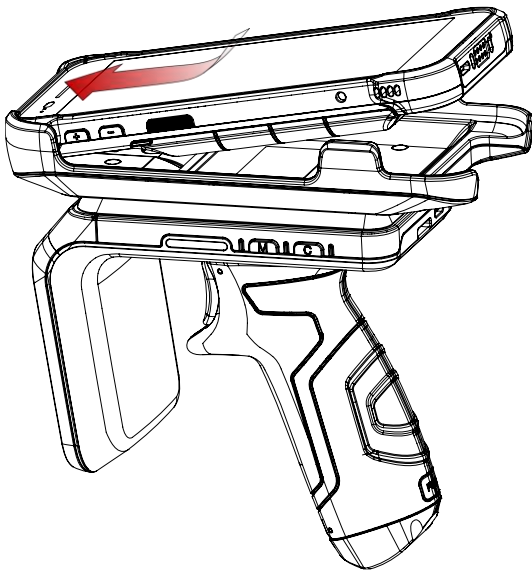


Note: Find more detail in *RF750 User manual* or *RFID Control User Guide*.

To attach the PM75 onto the RF750,

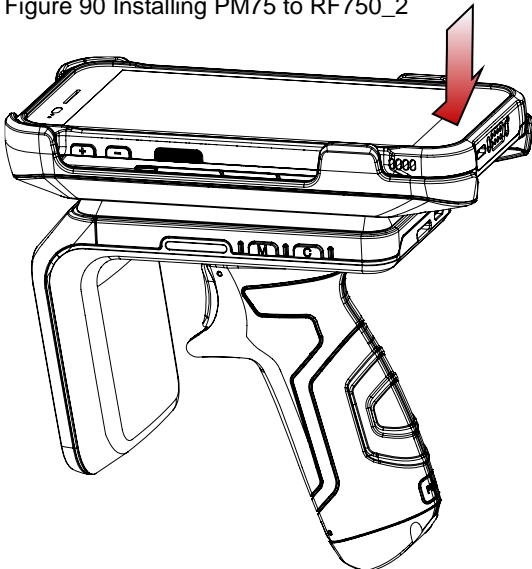
1. Insert the PM75 into the retention fixture of the RF750 from top.

Figure 89 Installing PM75 to RF750_1





2. Push the bottom of the PM75 down.

Figure 90 Installing PM75 to RF750_2



System Maintenance

System information

There are two ways for checking system information, on **settings**  and on **EmKit** .

On Settings

Go to **Settings**  > **About phone** . Following information can be found.

- Device name
- Phone number
- Emergency information
- Legal information & Certificates
- Model & SIM status
- Hostname
- Android version
- IMEI
- IP address
- Wi-Fi MAC address
- Bluetooth address
- Build number

On EmKit

Go to **EmKit**  > **System Information** . Following information can be found.

- Processor information
- Version information (Android version, OS image version, SDK version, etc.)
- Manufacturer information (Serial number, Part number, etc.)
- Device information (Scanner, Camera, Audio, Display, etc.)
- Battery information (Battery charging status, etc.)
- App version information (Version of EmKit apps)

System Maintenance

Check Device Health

EmHealthReport is a solution that provides the device's battery and eMMC health.

Monitor the battery and eMMC status to foresight their lifetime or find the cause when there is a battery problem such as cannot charge the device or rapid battery discharge.



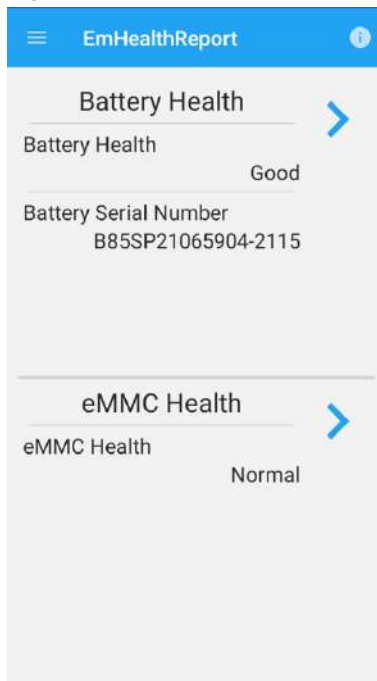
To use, open **EmKit**  and launch **EmHealthReport** . You can see the simple device health information on main screen. To find detailed information, tap each blue arrow on the right side of the screen.

Figure 91 EmHealthReport



- **Battery Health**
 - Battery Level
 - Battery Health
 - Battery Voltage
 - Battery Temperature
 - System Temperature
 - Battery Manufacture Date
 - Battery Serial Number
- **eMMC Health**
 - Pre-EOL Information
 - Device life time estimation type A
 - Device life time estimation type B

System Maintenance

OS Update

Periodic update improves the performance of the device. Point Mobile provides up-to-date OS version via Service Portal and FOTA. Update the device via storage, OTG port, and FOTA server. Depending on the workspace environment, choose more suitable method.



Notice: Please backup your data before starting the update process.

OS update via storage

To update the OS using storage,



1. Download an OS image file into the root folder of microSD card or device internal storage
2. (In case of using SD card) Insert SD card to the device and then turn the device on
3. Go to **Settings**  > **System**  > **Advanced** > **System Update**
4. Check if the OS image file shows up under **AVAILABLE VERSIONS**

Figure 92 OS update via storage



5. Tap **UPDATE** to start the update process





Note: If the OS image file doesn't show up in **AVAILABLE VERSIONS**, check the file is placed in the root folder of storage. System only can recognize the file in the root folder.

System Maintenance

OS update via OTG port

PM75 supports the USB OTG feature.

1. Prepare a formatted USB flash drive for OS update
2. Copy an OS image file to the root folder of the flash drive
3. Connect the flash driver to the PM75
4. Go to **Settings**  > **System**  > **Advanced** > **System Update**
5. Check if the OS image file shows up under **AVAILABLE VERSIONS**
6. Tap **UPDATE** to start the update process

OS update via FOTA

If PM75 can connect to a network, use the FOTA server for the update.



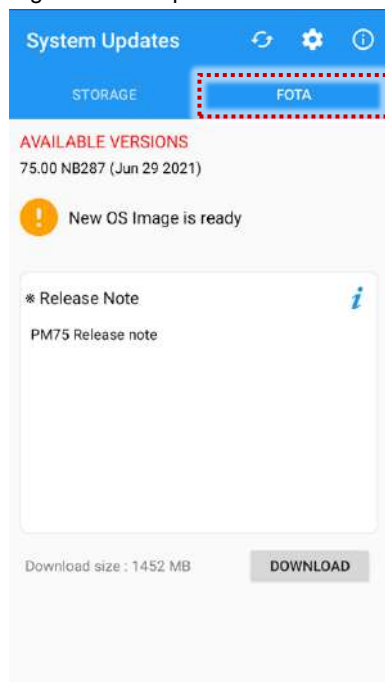
1. Connect the device with a network
2. Go to **Settings**  > **System**  > **Advanced** > **System Update**
3. Tap **FOTA** tab or Swipe left to move to **FOTA** tab
4. If there is an OS version newer than device's one, the server shows the new OS information

Figure 93 OS update via FOTA

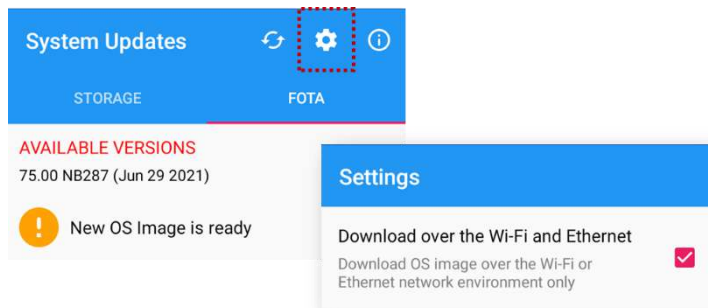


System Maintenance

5. Tap **Download**
6. Tap **OK** on the **OS Update** dialog to start to download the OS image file
7. To complete the update, rebooting is required. Tap **OK** on the **Restart required** dialog to restart the device

Note: Basically, OS update via FOTA works over Wi-Fi or Ethernet only. To enable the OS update over Mobile Network too, uncheck the setting value in FOTA Settings. Downloading over the Mobile network may result in additional charges.

Figure 94 FOTA Settings



System Maintenance

Factory Data Reset

When PM75 work abnormal or there is a need to reset the device, follow the steps below to perform a factory data reset.



Caution: *Factory data reset will erase all personalized settings and data saved in the device, such as Google account, apps, user data, etc. And factory data reset cannot undo.*

Factory data reset via Settings app

If the device can be turned on and access **Settings**,



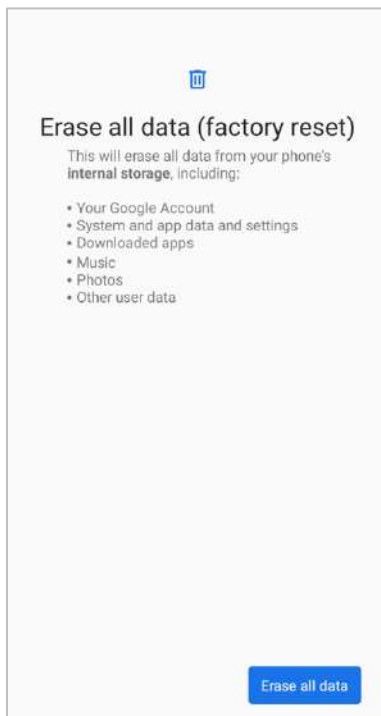
1. Navigate to **Settings**  > **System**  > **Advanced** > **Reset options**
2. Tap **Erase all data (factory reset)**
3. After being aware that factory reset will erase all data from the internal storage, tap **Erase all data**

Figure 95 Factory data reset



4. Tap **Erase all data** again to start the factory reset process

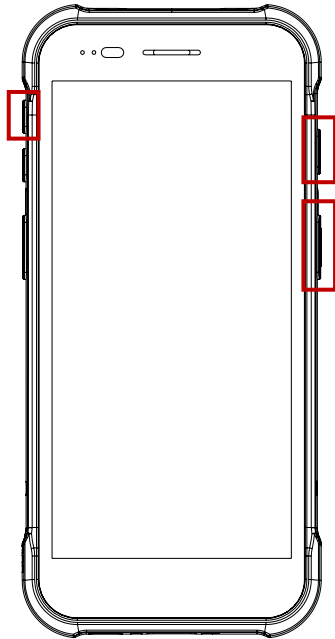
System Maintenance

Factory data reset via recovery mode

If device works abnormal so does not turn on, try to perform factory data reset through Android recovery mode.

1. Press and hold **power button + volume up + scan (Right)** buttons simultaneously when PM75 turned off.

Figure 96 Recovery mode button combination



2. After short vibration, release the power button
3. Using the keys below, select **Wipe data/factory reset**
 - **Move down / up** – Press volume down / up button
 - **Select the menu** – Press power button
4. After wiping the data, select **Reboot system now**

Accessories

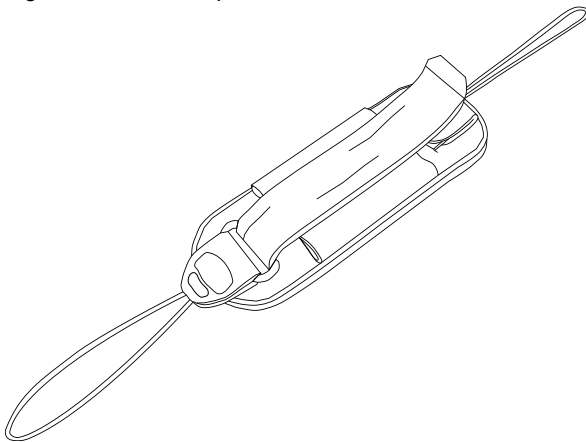
There are two types of PM75 accessory, standard and optional. In standard package, a hand strap is included. And PM75 supports below optional (sold separately) accessories.

Category	Accessory Name	Usage
Sled type	Gun handle	Provide additional scan trigger button (Programmable)
	RF750	Reading RFID tags
Charging cradle	SSC (Single Slot Cradle)	Charge one PM75 and one PM75 battery Provide USB type C port
	2SC (2 Slot Cradle)	Charge up to two units of PM75
	4SBC (4 Slot Battery Cradle)	Charge up to four pieces of PM75 batteries (Common with PM85 battery)

Hand Strap

The hand strap is enclosed in the PM75 standard package. Attach the strap and you can grab the device more firmly.

Figure 97 Hand strap

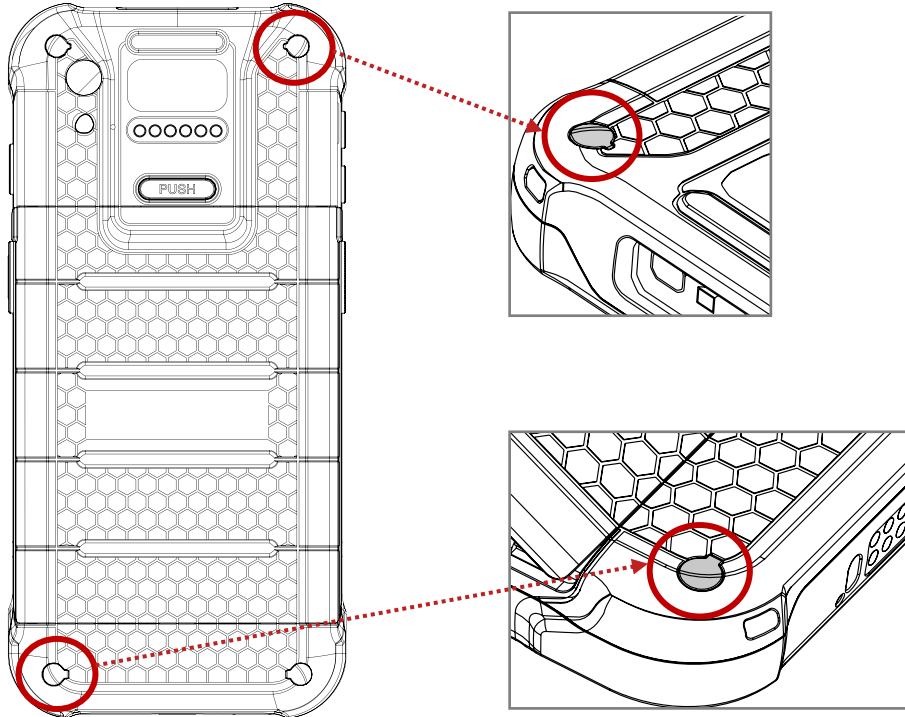


Accessories

Attach hand strap

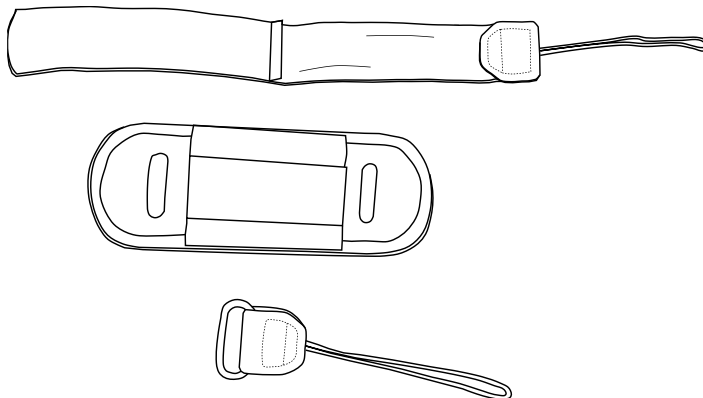
1. Using a sharp tool, detach the rubbers on the marked location in the figure below.

Figure 98 Attach hand strap_1



2. Disassemble the hand strap into three parts.

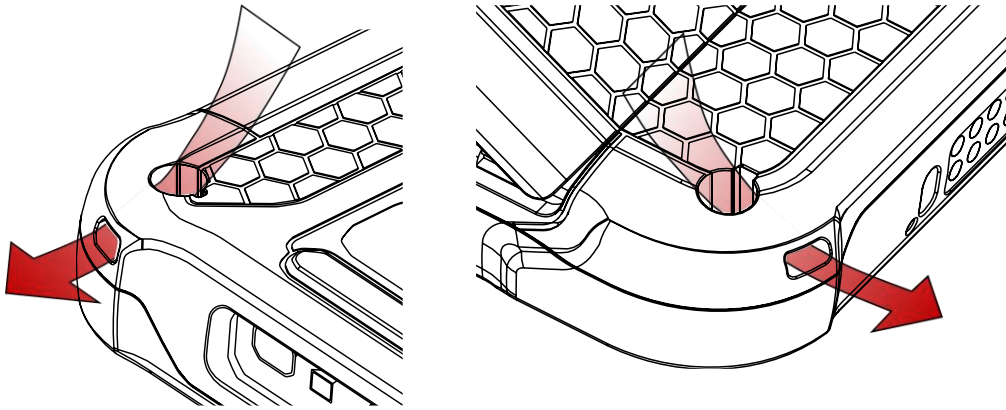
Figure 99 Attach hand strap_2



Accessories

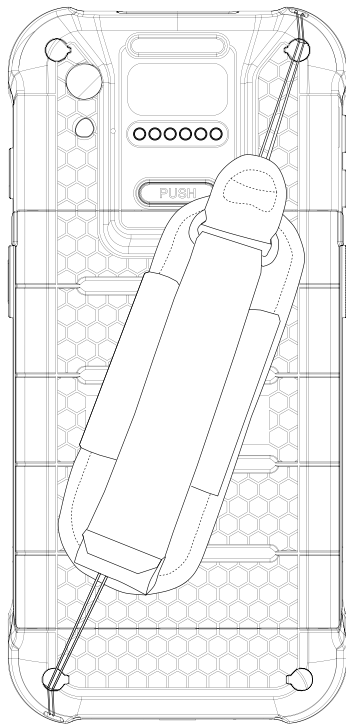
3. Slide the thin ropes of the strap parts into the hand strap holes.

Figure 100 Attach hand strap_3



4. Pass the other end through the loop of the rope, and pull it tight.
5. Reassemble the hand strap parts.

Figure 101 Hand strap attached



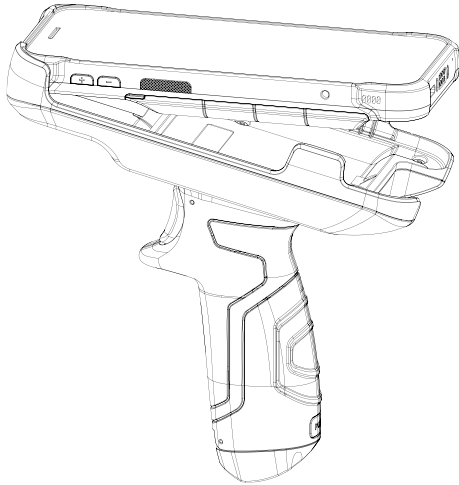
Accessories

Gun Handle

Attach & Use gun handle

Attach PM75 to the gun handle from top side, and push the bottom firmly.

Figure 102 Attach PM75 to gun handle



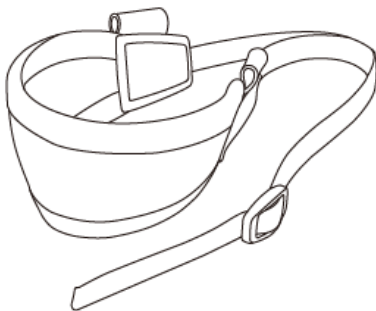
With gun handle, you can use additional programmable button. The button is used for triggering scanner usually.

If you want to change the function mapped to the trigger button, access [Program Buttons](#) and set **SCANNER_B** to the desired function.

Attach hand strap

A hand strap is enclosed in the gun handle package. Attach the strap and carry the device more comfortably.

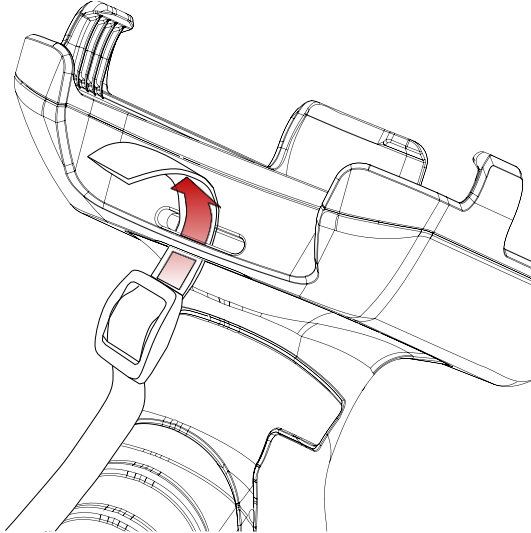
Figure 103 Gun handle - hand strap



Accessories

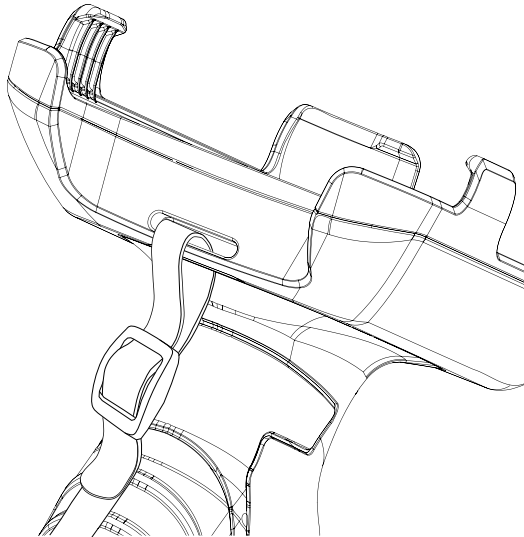
1. Thread the strap through the hole on the bottom side of the retention fixture.

Figure 104 Gun handle - Attach hand strap_1



2. Slide the strap through the buckle at the appropriate length.

Figure 105 Gun handle - Attach hand strap_2



Accessories

RF750 (RFID Sled)

Connect PM75 and RF750 to read RFID tags. To connect the devices, RFID Control application is required.

For more detail, see [RFID](#) chapter or RF750 User Manual.

Charging cradle

Single Slot Cradle (SSC)

SSC can charge the followings.

- PM75 only
- PM75 + Sled type accessory (gun handle or RF750) mounted

PM75 and RF750 will be charged simultaneously when using SSC.

For more detail, find [Charge the device – SSC](#) chapter or SSC Quick start guide.

2SC (2 Slot Cradle)

2SC has 2 device slots so it can charge up to two units of PM75 simultaneously. And it can charge the PM75 only.

And the cradle can be assembled with up to two more 2SC for share cradle. It can become 4SC (Assemble two pieces), and 6SC (Assemble three pieces).

For more detail, find [Charge the device – 2SC](#) chapter or 2SC Quick start guide.

4SBC (4 Slot Battery Cradle)

4SBC has 4 battery slots so it can charge up to four pieces of PM75's battery simultaneously. The cradle is common for PM85 batteries.

For more detail, find [Charge the device – 4SBC](#) chapter or PM85 4SBC Quick Start Guide.

Safety Information

Battery Safety Information

Follow battery safety guidelines in this manual for safe usage and disposal of Li-ion batteries. Improper battery usage may result in an explosion, fire, or other critical hazards.

Battery Usage & Disposal Guidelines

1. Use only Point Mobile approved batteries and charging accessories. Other batteries and charger may damage the device.
2. Do not disassemble or modify the battery. Do not bend, shred, deform the battery.
3. Do not expose the battery to excessive heat or cold. Do not place the battery into a microwave oven or dryer.
4. Do not short-circuit the battery or allow a foreign object to battery contacts.
5. Do not burn, expose to water, or other liquids the battery.
6. If battery leakage is observed, avoid any contact with the skin or eyes. If contact has been made, wash the affected area with water for 15 minutes, and seek medical attention.
7. Follow the local regulations for the disposal of used batteries.
8. Do not store or charge the battery in direct sunlight or in areas prone to get hot such as in a parked vehicle, near a heat duct, or close to other heat sources.

Battery Charging Guidelines

1. Do not charge the battery in or near areas with materials that could obstruct charging or cause a short-circuit.
2. Do not charge the battery in the excessive hot or cold area.
3. Separate the charger from the battery as soon as possible when the battery is fully charged.

Safety Information

Battery Storage Guidelines

Storing the batteries is as important as using it safely. Battery is a core part of the device's performance so that you should treat the batteries safely.

1. Batteries should be stored in the clean, dry and ventilated environment within ambient temperature ranges of 20 ± 5 °C
2. Keep batteries away from corrosive substances.
3. Keep batteries away from fire and heat.
4. Batteries are charged while producing to below 20 ~ 30 % of full capacity for safety regulations.
5. Charge it for 30 minutes –1hour t least once every six months to prevent full discharge and keep the performance, when you are not using the battery for a long period.



Notice: *The battery is consumable goods. Point Mobile provides warranty for battery in 6 months after purchase.*

If you suspect the battery swelling, change the battery and contact Point Mobile to use safely.



Point Mobile. Co., Ltd.

Offline

Tel: +82-2-3397-7870~1

ARS: +82-1800-3010

Fax: +82-2-3397-7872

Address: 9F Kabul Great Valley, 32, Digital-ro 9-gil,
Geumcheon-gu, Seoul, Korea 08512

Online

Website: <https://www.pointmobile.com>

E-mail: pm_support@pointmobile.com