

Honeywell

THE POWER OF **CONNECTED**

RP2/RP4*

Mobile Printers



User Guide

* For China, models RP2B-C, RP2D-C, RP4B, RP4D-C

*For Thailand models RP2B, RP2D-T, RP4B, RP4D-T

Disclaimer

Honeywell International Inc. (“HII”) reserves the right to make changes in specifications and other information contained in this document without prior notice, and the reader should in all cases consult HII to determine whether any such changes have been made. The information in this publication does not represent a commitment on the part of HII.

HII shall not be liable for technical or editorial errors or omissions contained herein; nor for incidental or consequential damages resulting from the furnishing, performance, or use of this material. HII disclaims all responsibility for the selection and use of software and/or hardware to achieve intended results.

This document contains proprietary information that is protected by copyright. All rights are reserved. No part of this document may be photocopied, reproduced, or translated into another language without the prior written consent of HII.

Copyright © 2017-2018 Honeywell International Inc. All rights reserved.

Web Address: www.honeywellaidc.com

Microsoft[®] Windows[®] 7, Windows[®] 8, Windows[®] Mobile, and Windows[®] CE are trademarks or registered trademarks of Microsoft Corporation.

Wavelink[®] Avalanche[™] is a registered trademark of Wavelink Corporation.

The Bluetooth[®] word mark and logos are owned by Bluetooth SIG, Inc.

Android[™] is a trademark of Google Inc.

Other product names or marks mentioned in this document may be trademarks or registered trademarks of other companies and are the property of their respective owners.

For patent information, refer to www.hsmpats.com.

Firmware (Software) Agreement

The enclosed firmware (software) resident in the printer is owned by Licensor or its suppliers and is licensed for use only on a single printer in the user’s trade or business. The user agrees not to, and not to authorize or permit any other person or party to, duplicate or copy the firmware or the information contained in the non-volatile or programmable memory. The firmware (software) is protected by applicable copyright laws and Licensor retains all rights not expressly granted. In no event will Licensor or its suppliers be liable for any damages or loss, including direct, incidental, economic, special or consequential damages, arising out of the use or inability to use the firmware (software).

TABLE OF CONTENTS

Customer Support	v
Technical Assistance	v
Product Service and Repair	v
Limited Warranty	v
Send Feedback	v
Chapter 1 - Get Started	1
Introduction	1
Unpack Your Device.....	1
About the Battery	2
Charge the Battery.....	2
Download Required Software.....	3
Default USB Connection.....	4
Configure Printer.....	4
Safety Precautions for Lithium Batteries	5
Proper Disposal of the Battery	6
Important Safety Instructions.....	6
Chapter 2 - Load the Media	7
Load Labels or Paper.....	7
External Media.....	9
Configure the Media	10
Media Types and Settings	11

Chapter 3 - Program the Interface..... 13

USB Connection	13
Default USB Connection	14
USB Settings	14
Configure Printer	14
Bluetooth Connection.....	17
Bluetooth Settings	17
Tap and Pair.....	18
Wireless LAN Connection.....	18
Static IP/DHCP.....	19
Dynamic IP Address (DHCP).....	19
Static IP Address	19
Infrastructure/Ad-hoc	19
Wireless LAN Security	20
WEP 64 and 128 Bit.....	20
WPA2-PSK with CCMP.....	20
WPA2-PSK with TKIP	21
WPA2-Enterprise	21
WPA-PSK with TKIP.....	21

Chapter 4 - Printer Display and Buttons 23

Front Panel.....	23
On/Off Button	23
Media Button	23
LED Display	24
Audible Indicators	24
Set Sleep and Power Down Timer.....	25
Real-Time Clock (RTC).....	25
Set the Date and Time	25

Chapter 5 - Calibration..... 27

Calibrate the Media.....	27
Quick Media Calibration.....	27

Manual Media Calibration	28
Gap Type Labels	28
Black Mark Labels	29
Chapter 6 - Configuration Files.....	31
Print Configuration Label.....	31
Save and Load Configuration Files.....	31
Save a Configuration File	31
Load a Configuration File.....	31
Chapter 7 - Maintenance	33
Battery Charge Information.....	33
Health Status	33
Gas Gauge	34
Change the Battery	34
Cleaning Intervals.....	35
Maintenance Schedule.....	35
Clean the Printhead.....	36
Standard RP4 Models	36
Linerless Models	36
Firmware Update.....	37
Chapter 8 - Troubleshooting.....	39
Chapter 9 - Product Specifications	41
RP2 Printer Specifications	41
RP4 Printer Specifications	42
Required Safety Labels.....	45
RP2Printer.....	45
RP4Printer.....	45
Fonts.....	45
Bar Code Symbolologies	46
Graphics.....	46

Software and Firmware	46
Control Language Compatibility	46
Device Management Support and Compatibility.....	46
Network Compatibility.....	46
O/S Support	46
Label Design Software Compatibility	46
ERP Systems	47
Software Development Kit	47

Chapter 10 - Accessories 49

Belt Clip.....	49
Shoulder Strap/Hand Strap (RP4 Printer Only)	49
Belt Loop	50
Soft Case	50
USB On-the-Go	51

Chapter A - Printer Language Emulation..... 53

Chapter B - Print Demo..... 55

NETira CT Printer Demo.....	55
-----------------------------	----

Customer Support

Technical Assistance

To search our knowledge base for a solution or to log in to the Technical Support portal and report a problem, go to www.hsmcontactsupport.com.

For our latest contact information, see www.honeywellaidc.com/locations.

Product Service and Repair

Honeywell International Inc. provides service for all of its products through service centers throughout the world. To obtain warranty or non-warranty service, return your product to Honeywell (postage paid) with a copy of the dated purchase record. To learn more, go to www.honeywellaidc.com and select **Service & Repair** at the bottom of the page.

Limited Warranty

For warranty information, go to www.honeywellaidc.com and click **Get Resources > Product Warranty**.

Send Feedback

Your feedback is crucial to the continual improvement of our documentation. To provide feedback about this manual, contact the Honeywell Technical Communications department at ACSHSMTechnicalCommunications@honeywell.com.

Introduction

The RP Series printer family blends the rugged durability with state-of-the-art electronics and user-friendly features to redefine the standard in portable thermal printers. The printer's USB, WiFi LAN, or Bluetooth® technology offers an easy interface to any host system.

To print labels or receipts, refer to the instructions included with the software you use to create the labels.

A Windows® printer driver can be found on our website, www.honeywellaidc.com.

Unpack Your Device

After you open the shipping carton containing the product, take the following steps:

- Check for damage during shipment. Report damage immediately to the carrier who delivered the carton.
- Make sure the items in the carton match your order.
- Save the shipping container for later storage or shipping.

In order to print from your printer, the following items are required. If you do not have these items, contact your customer-support or sales representative for advice on where to purchase the items or where the required software can be downloaded.

- **Power Supply (sold separately)**
The appropriate power supply for your region is required and is not included as part of the printer purchase. If you do not have an applicable power supply for your printer, you will need to order one.
- **Connection Cable**
You will need a standard Mini B to USB A cable if you are connecting your printer via USB.

- **Print Media**
Honeywell offers a full line of applicable printing labels, receipt media, and supplies.

About the Battery

Power is supplied to the printer by a rechargeable lithium ion battery. Batteries are shipped only partially charged. The battery should be charged for a minimum of 4 hours before initial use to ensure optimal performance.



Warning: The maximum operating temperature of the printer is 122°F (50°C), however the maximum operating temperature for charging when used with a Honeywell power supply is limited to 104°F (40°C). Charge the printer in a location that meets this temperature requirement.

See [Battery Charge Information](#) on page 33 for further information about the battery.

Charge the Battery

1. Install the battery in the printer. Align the release tab with the same side as the charge contacts and lock the battery into position. The latch clicks into place when properly seated.

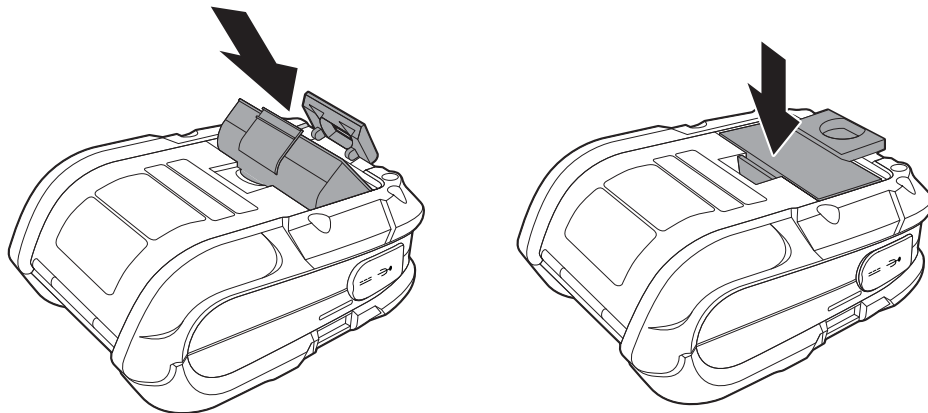

2. Connect the power supply to printer's power jack.

3. Connect the AC power cord to the power supply and plug into an outlet.

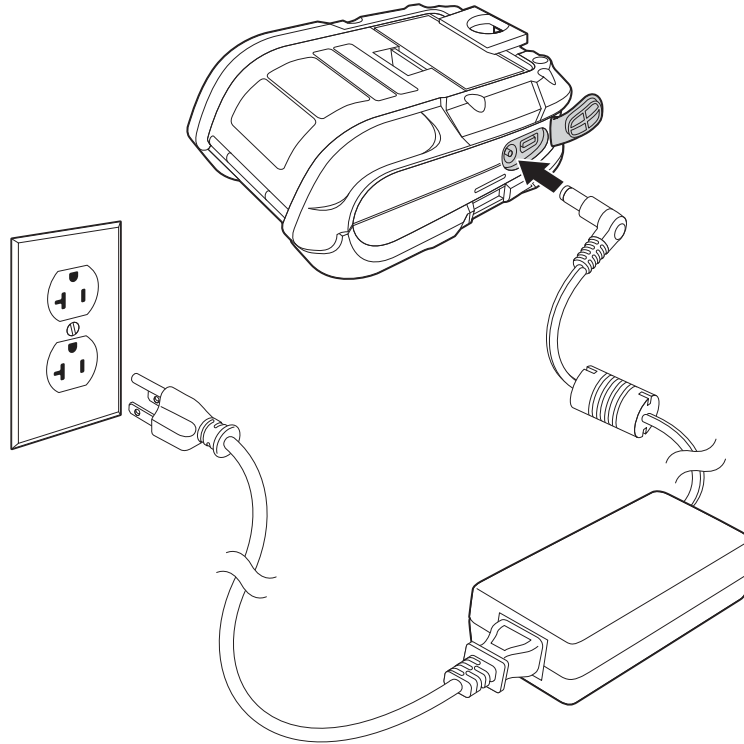

Warning: Do not operate the printer while it is connected to the AC power supply.

Download Required Software

1. Create a new folder on your local computer named **Drivers**.
2. Go to the Technical Support Downloads Portal at <https://hsmftp.honeywell.com>.
3. Go to:
 - Software**
 - Printers**
 - Mobile - Portable**
 - RP2 RP3 RP4**
 - Utility**to download the NETira® CT Printer Configuration Utility.
4. When prompted, click on **Open Honeywell Software Downloader**.
5. Once the file has been downloaded, extract it to your **Drivers** folder.
6. Go to:
 - Software**
 - Printers**

- **Mobile - Portable**
- **RP2 RP3 RP4**
- **Drivers**
- **Printer**

to download the Windows Printer Drivers (for DPL Input Mode).

7. When prompted, click on **Open Honeywell Software Downloader**.
8. Once the file has been downloaded, extract it to your **Drivers** folder.
9. Open the Drivers folder and double-click each of the setup.exe files. Follow the prompts to install each piece of software.

Default USB Connection

The default USB class is CDC Composite. On some systems (e.g., handheld devices), you will have to change this USB class in order to connect. See [USB Connection](#) on page 13 for further information.

1. Connect the USB cable to the printer and to the USB port on the host system.
2. Power up your printer.
3. Your host computer should recognize the printer and begin adding the device driver. If the setup operation does not start, locate the **Devices and Printers** section in the Control Panel and select **Add a Printer**.
4. Select the appropriate RP printer model and follow the prompts to finish installation.

Configure Printer

1. Turn the printer on and connect it to the computer using the USB cable.
2. Open the NETira™ CT Printer Configuration Utility Tool.

3. Query the printer by clicking **Tools - Update Available Connections For Printer**. This will look for the USB Virtual COM Port.

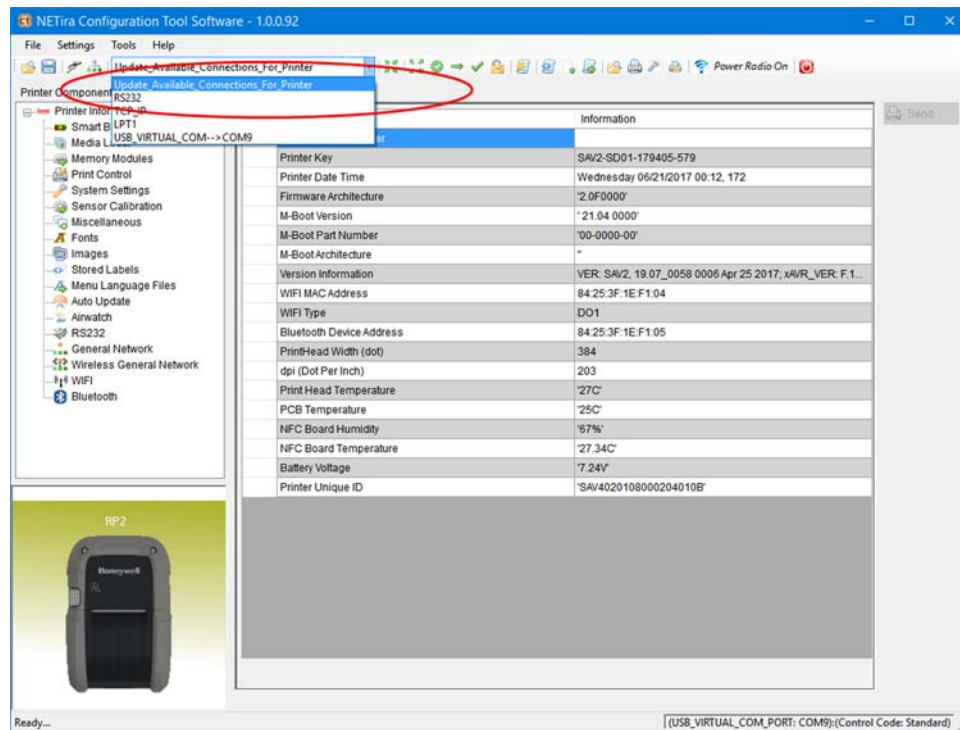

4. Once this is completed, reopen the dropdown menu and select the USB Virtual COM port.

Note: Make sure this port is not in use by the printer driver when you add it to the host system.

5. Select **Tools - Query Printer Configuration** (or press CTRL-q) to display the printer's configuration.

See [Program the Interface](#) beginning on page 13 for detailed information about changing your printer's settings.

Safety Precautions for Lithium Batteries

- Do not place batteries in fire or heat the batteries.
- Do not store batteries near fire or other high temperature locations.
- Do not store or carry batteries together with metal objects.
- Do not expose batteries to water or allow the batteries to get wet.
- Do not connect (short) the positive and negative terminals, of the batteries, to each other with any metal object.
- Do not pierce, strike or step on batteries or subject batteries to strong impacts or shocks.

- Do not disassemble or modify batteries.



Caution: There is a danger of explosion if the batteries are incorrectly replaced. Replace the batteries with only the same or equivalent type recommended by the manufacturer. Dispose of used batteries according to the recycle program for batteries as directed by the governing agency for the country where the batteries are to be discarded.

Proper Disposal of the Battery



When the battery has reached the end of its useful life, the battery should be disposed of by a qualified recycler or hazardous materials handler. Do not incinerate the battery or dispose of the battery with general waste materials. You may send the battery to us. (postage paid). The shipper is responsible for complying with all federal, state, and local laws and regulations related to the packing, labeling, manifesting, and shipping of spent batteries. Contact the Product Service Department ([Customer Support](#)) for recycling or disposal information. Since you may find that your cost of returning the batteries significant, it may be more cost effective to locate a local recycle/disposal company.

The printer is also designed with external-charging capabilities (optional) using Honeywell-approved charging accessories. For more information on available optional charging accessories, or a guide to using the multi-bay charging accessory, go to www.honeywellaidc.com.

Important Safety Instructions

This printer has been designed to provide many years of safe, reliable performance. As with all types of electrical equipment, however, there are a few basic precautions you should take to avoid hurting yourself or damaging the equipment:

- Read the installation and operating instructions.
- Read and follow all warning instruction labels on the printer.
- Make sure all openings on the printer remain unblocked. Never insert anything into the openings or ventilation slots.
- Do not place the printer near a heat source.
- Do not use your printer near water or spill liquid into it.
- Be certain that your power source matches a listed voltage rating for the printer (if unsure, check with your dealer or local utility company).
- Do not place the power cord where it can be stepped on and, if the power cord becomes damaged, immediately replace it.

If service is required, use only qualified trained technicians to repair your printer. See [Customer Support](#).

Load Labels or Paper

Load labels or paper into the printer as follows:

1. Press down on the latch lock and lift up the printer's cover.

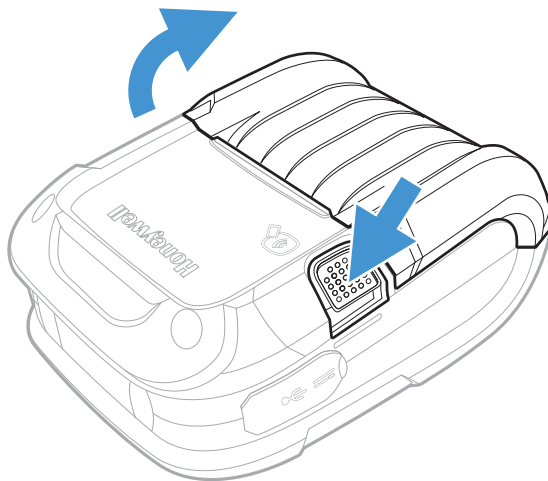

2. Slide and hold open the supply hubs.

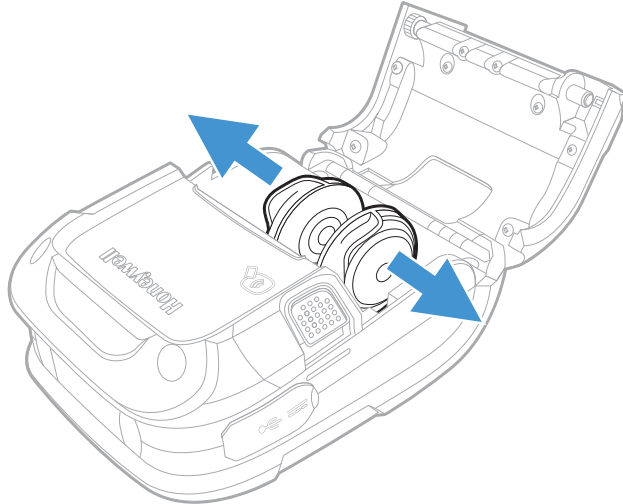

3. Orient the paper as shown and insert into the printer.

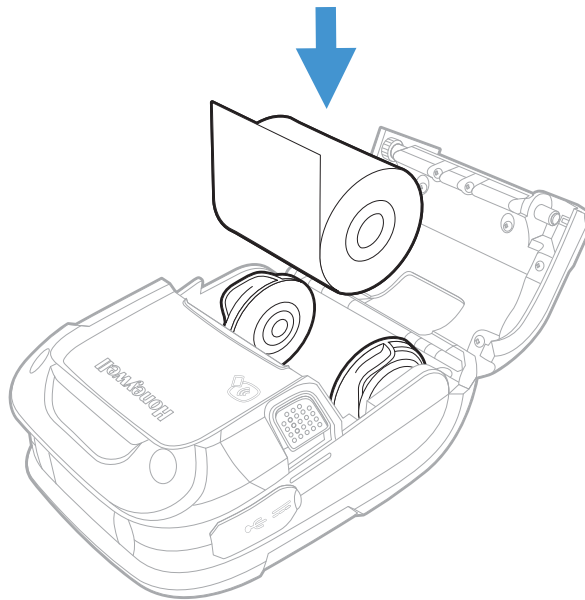

4. Allow the supply hubs to retract onto the paper roll and press the cover down until it latches.
5. Press the media button  2 or 3 times to normalize tracking. Each button press advances the paper to the start of the next label.

External Media

1. Press down on the latch lock and lift up the printer's cover.

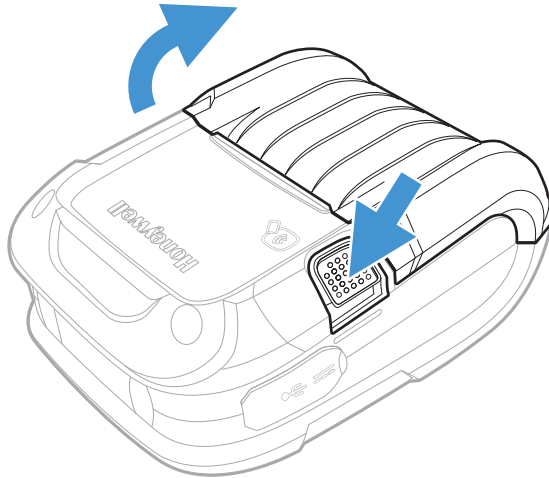

2. Open the external media door located under the supply hubs.
3. Slide and hold open the supply hubs and install the media spacer.

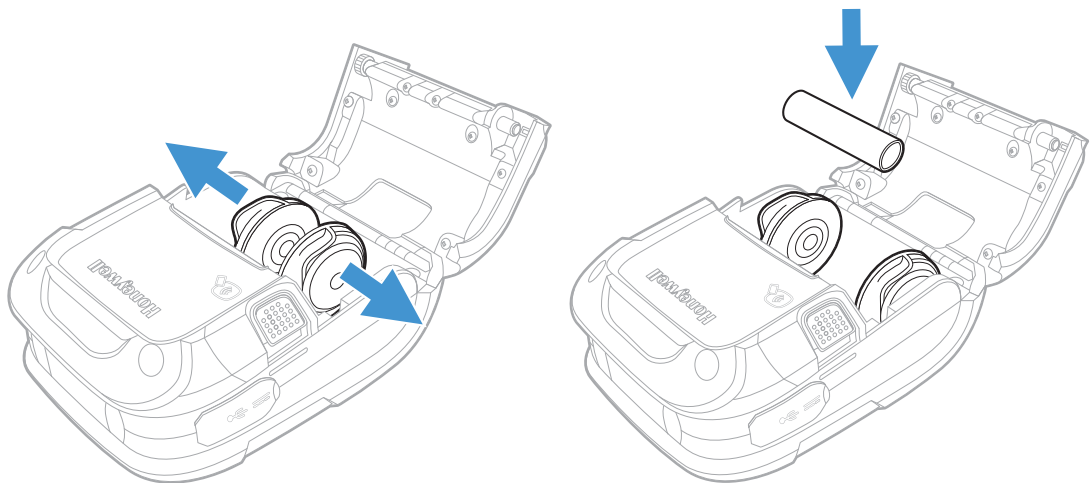

4. Insert the media through the external media door and through the printer.

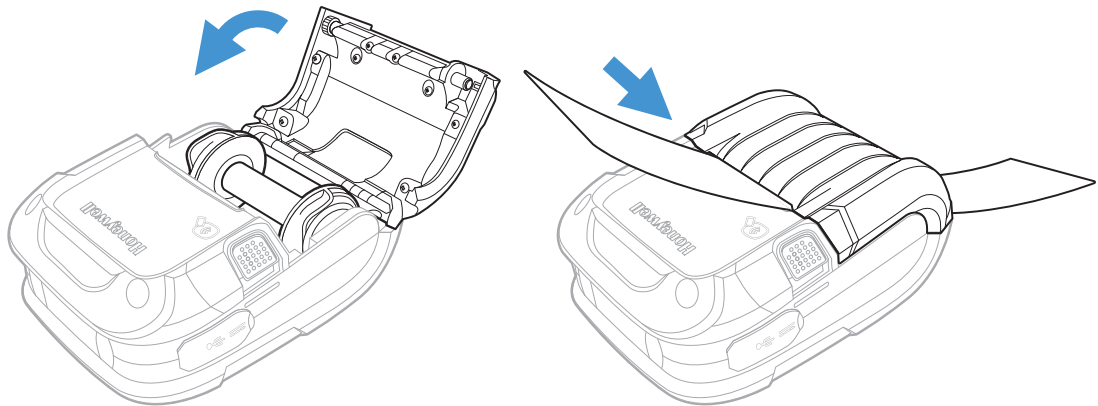

- Press the media button  2 or 3 times to normalize tracking. Each button press advances the paper to the start of the next label.

Configure the Media

Note: If you haven't downloaded the drivers and software, you must do so now. See [Download Required Software](#).

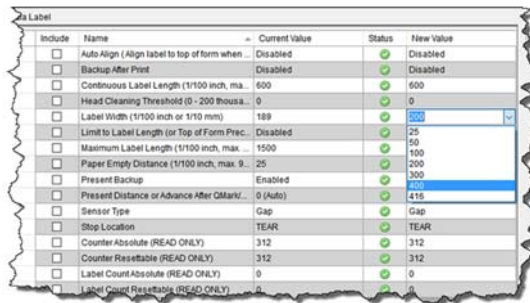

Most applications use the printer's default media setting of **Gap**, for gap labels. However, if reflective (black mark), or continuous media is used, you must change the printer's settings.

- Turn the printer on. If you are using a USB interface, connect the USB cable to the computer.
- Open the NETira CT Printer Configuration Utility Tool and click on **Tools - Query Printer Configuration** (or press CTRL-q) to query the printer.
- Under **Printer Information**, select **Media Label**.
- Click in the entries under the **New Value** column to update the settings for your media type. Each setting will have a dropdown list from which you can choose a new value.

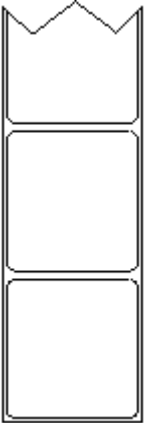
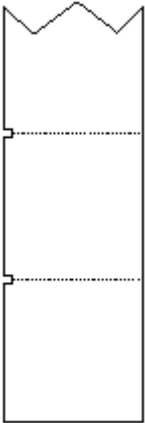

Include	Name	Current Value	Status	New Value
<input type="checkbox"/>	Auto Align (Align label to top of form when	Disabled	✔	Disabled
<input type="checkbox"/>	Backup After Print	Disabled	✔	Disabled
<input type="checkbox"/>	Continuous Label Length (1/100 inch, ma...	600	✔	600
<input type="checkbox"/>	Head Cleaning Threshold (0 - 200 Thousa...	0	✔	0
<input type="checkbox"/>	Label Width (1/100 inch or 1/10 mm)	189	✔	300
<input type="checkbox"/>	Limit to Label Length (or Top of Form Prec...	Disabled	✔	25
<input type="checkbox"/>	Maximum Label Length (1/100 inch, max...	1500	✔	50
<input type="checkbox"/>	Paper Empty Distance (1/100 inch, max. 9...	25	✔	200
<input type="checkbox"/>	Present Backup	Enabled	✔	300
<input type="checkbox"/>	Present Distance or Advance After CMarV...	0 (Auto)	✔	415
<input type="checkbox"/>	Sensor Type	Gap	✔	Gap
<input type="checkbox"/>	Stop Location	TEAR	✔	TEAR
<input type="checkbox"/>	Counter Absolute (READ ONLY)	312	✔	312
<input type="checkbox"/>	Counter Resettable (READ ONLY)	312	✔	312
<input type="checkbox"/>	Label Count Absolute (READ ONLY)	0	✔	0
<input type="checkbox"/>	Label Count Resettable (READ ONLY)	0	✔	0

Media Types and Settings

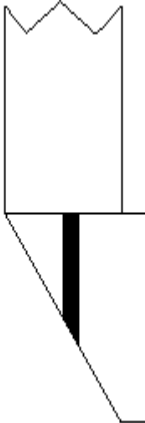
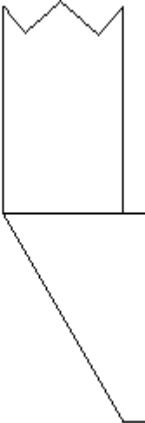
Media Type				
Gap Label	Notch Edge	Notch Center	Reflective (Black Mark)	Continuous
				
Sensor Type				
Gap	Not Supported	Gap	Black Mark (Top or Bottom)	Continuous Label Length (set value)

Setting	Description
Continuous Label Length (1/100 inch)	Distance the printer will advance after pressing the Media Feed button. Distance is measured in 1/100 inch, so 1000 = 10 inches.
Label Width (1/100 inch)	200 = 2 inch media 300 = 3 inch media 400 = 4 inch media
Maximum Label Length (1/100 inch)	Distance must be greater than the length of your media. Distance is measured in 1/100 inch, so 1000 = 10 inches.
Sensor Type	Gap = labels with gap Continuous = media with no gap Reflective = labels with Q-mark or black mark

- After updating the **New Value** column, click the **Send** button to send this change to the printer.
- Allow 30 seconds for the printer to reset.

If you have issues with media registration after sending these settings to the printer, refer to [Calibrate the Media](#) on page 27.

PROGRAM THE INTERFACE

You can communicate with the host via [USB Connection](#), [Wireless LAN Connection](#), or [Bluetooth Connection](#). The printer automatically connects to the first available port that provides valid data. To change that connection once it is established, power the printer off and back on again. Use the appropriate instructions that follow for your interface.

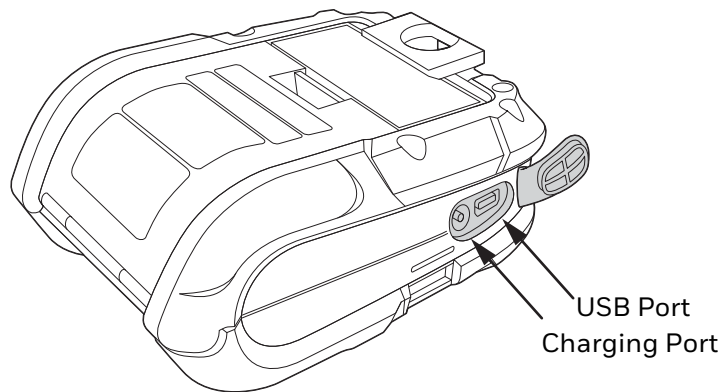

Note: Power off the printer before connecting a power or an interface cable.

Note: If you haven't downloaded the drivers and software, you must do so now. See [Download Required Software](#).

USB Connection

Note: You will need a standard Mini B to USB A cable if you are connecting your printer via USB.

The USB Interface is supported in Windows 7.0 and greater. An Internet connection may be required. You may also need administrative access rights to your host computer for completing this installation. If you do not, you will need to log off and log in under a profile that has administrative rights for your host computer.

Default USB Connection

The default USB class is CDC Composite. On some systems (e.g., handheld devices), you will have to change this USB class in order to connect. See [USB Connection](#) for further information.

1. Connect the USB cable to the printer and to the USB port on the host system.
2. Power up your printer.
3. Your host computer should recognize the printer and begin adding the device driver. If the setup operation does not start, locate the **Devices and Printers** section in the Control Panel and select **Add a Printer**.
4. Select the printer model.

Once completed, you should see the available printer on your host PC. You can adjust the printer's USB settings using the instructions that follow.

USB Settings

The type (or class) of USB connection for the host must be determined. The following USB connections are supported:

- CDC (Communication Device Class)
- Printer Class (Typical Windows® Printer)
- Composite (CDC/Printer Class)

Whenever possible, you should use the default setting, Composite (CDC/Printer Class), as it gives the most flexibility. However, on some systems (e.g., handheld devices), CDC or Printer Class should be selected since handheld devices have limited support.

Configure Printer

1. Turn the printer on and connect it to the computer using the USB cable.
2. Open the NETira™ CT Printer Configuration Utility Tool.

3. Query the printer by clicking **Tools - Update Available Connections For Printer**. This will look for the USB Virtual COM Port.

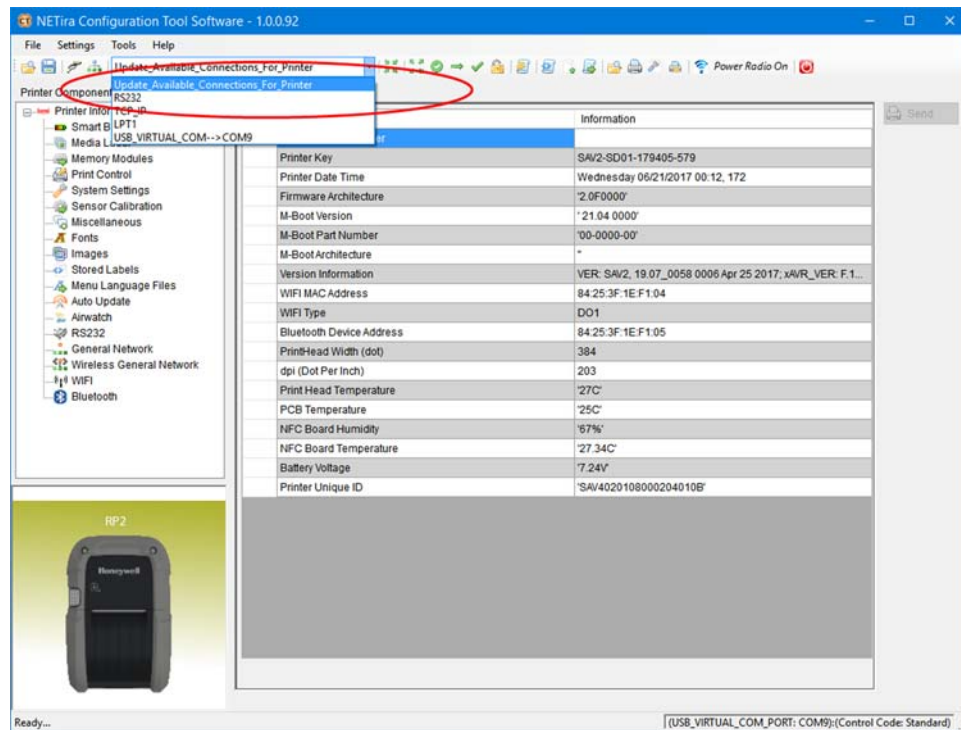

4. Once this is completed, reopen the dropdown menu and select the USB Virtual COM port.
5. Select **Tools - Query Printer Configuration** (or press CTRL-q) to display the printer's configuration.
6. Under **Printer Information**, select **Miscellaneous**.

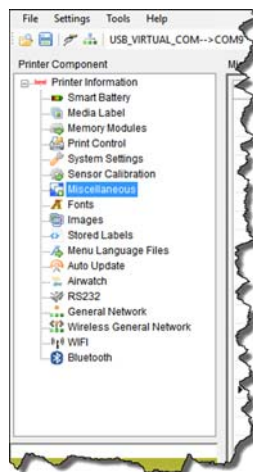

- Change (or confirm) the USB Mode parameter setting. Click on the dropdown arrow to display the list of possible settings.

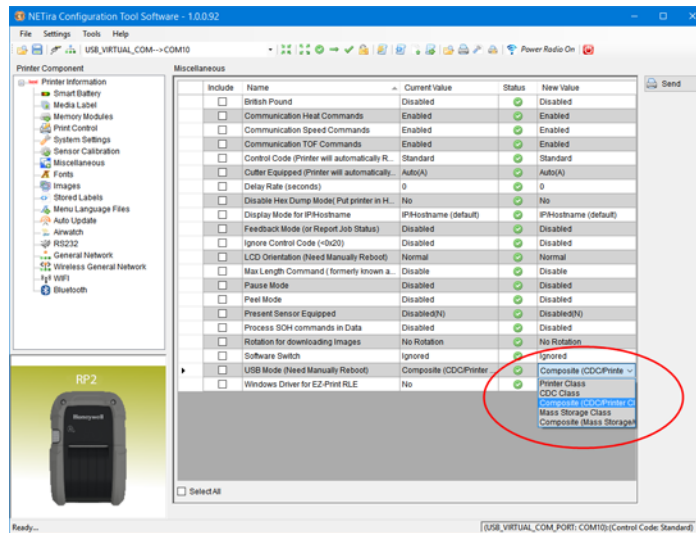

- Click the **Send** button to send this change to the printer.

DPL Input Mode

- Open the NETira CT Printer Configuration Utility Tool and click on **Tools - Query Printer Configuration** (or press CTRL-q) to query the printer.
- Go to **Tools - Set Input Mode**.

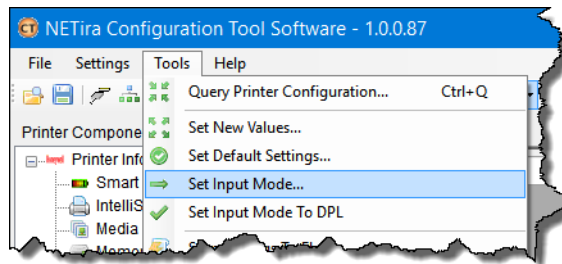

- Select the desired printer language from the dropdown. Click **Set** and **Done**.
- Click the **Send** button to send this change to the printer.

Allow 30 seconds for the printer to reset.

Note: The NETira CT Configuration Utility can only communicate with the printer using the DPL printer language input mode. Once the printer has been set to use an input mode other than DPL, the printer's input mode must be changed back to Auto or DPL when you need to communicate with NETira CT.

Bluetooth Connection

Follow your host PC or device instructions for pairing a new Bluetooth device. You should see the printer as an available printer from your host. The default pass code is **0000**. Once connected and the connection is established, adjust the printer's Bluetooth settings.

Bluetooth Settings

The printer is configured with default factory settings. To determine your printer's configuration, print a configuration label (see [Print Configuration Label](#)).

1. Open the NETira CT Printer Configuration Utility Tool and click on **Tools - Query Printer Configuration** (or press CTRL-q) to query the printer.
2. Under **Printer Information**, select **Bluetooth**.

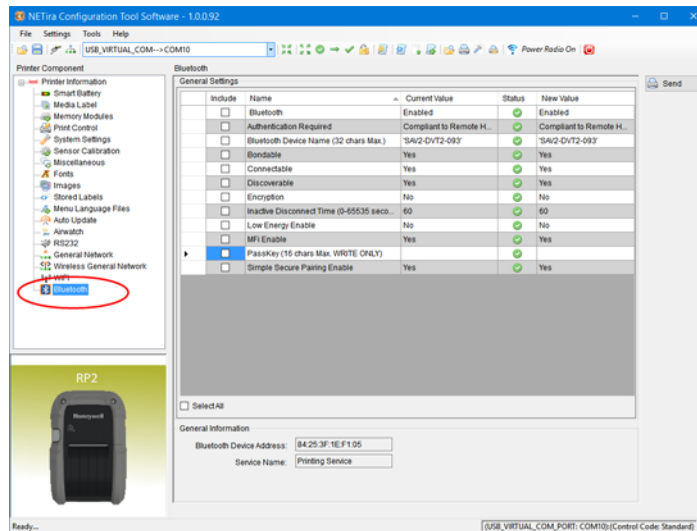

3. Change (or confirm) the following Bluetooth parameter settings:
 - **Bondable:** Yes
 - **Connectable:** Yes
 - **Discoverable:** Yes
 - **PassKey:** Default 0000 (must match entry used on host computer)
4. After updating the **New Value** column, click the **Send** button to send this change to the printer.
5. Allow 30 seconds for the printer to reset.

Tap and Pair

You can pair your Android™ phone with an RP2 or RP4 printer by touching the devices together.

1. Place the Android phone on the printer.
2. The phone recognizes the printer and prompts you to pair.
3. Verify the pairing of the printer in your phone's Bluetooth settings.

You can go to the Google Play Store and download the Honeywell Android NFC app to your phone, or use a printing application to send prints to the RP2 or RP4 printer.

Wireless LAN Connection

The printer makes IP requests at power-up, so before making a network connection to the printer consider how your IP address needs to be assigned. The IP address of the printer can be configured in one of two ways: use a static IP address or use IP discovery (DHCP, BootP or RARP).

1. Turn the printer on and connect it to the computer using the USB cable.
2. Open the NETira™ CT Printer Configuration Utility Tool.
3. Query the printer by clicking **Tools - Update Available Connections For Printer**. This will look for the USB Virtual COM Port.

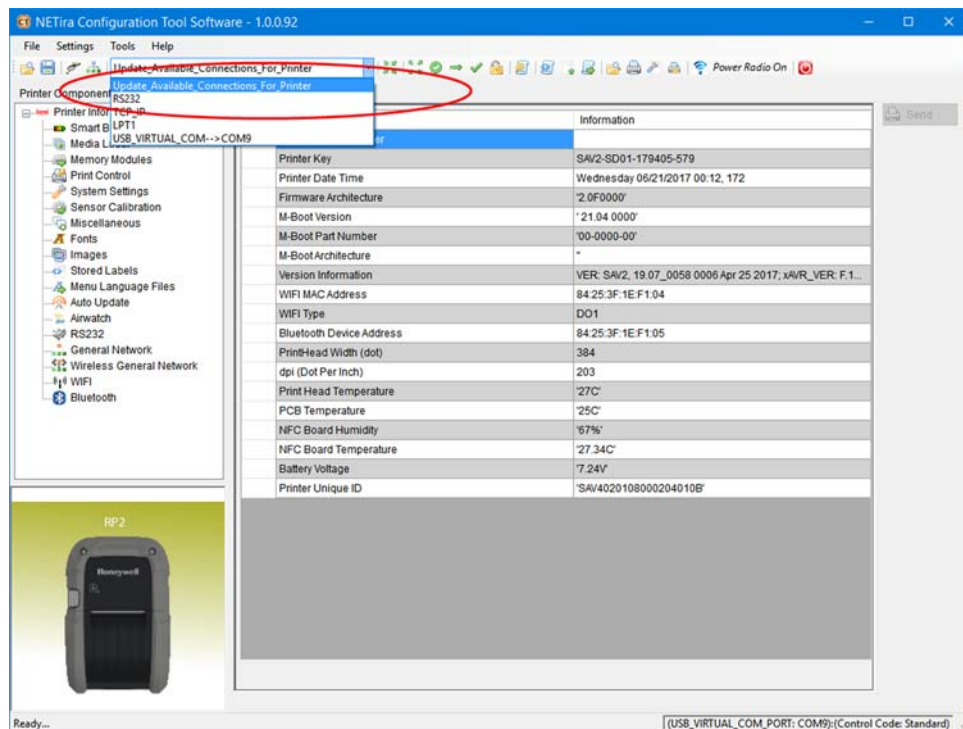

4. Once this is completed, reopen the dropdown menu and select the USB Virtual COM port.
5. Select **Tools - Query Printer Configuration** (or press CTRL-q) to display the printer's configuration.

Static IP/DHCP

The printer can be configured to use a static IP or a dynamic IP obtained from a DHCP server.

Dynamic IP Address (DHCP)

1. Open the NETira CT Printer Configuration Utility Tool and click on **Tools - Query Printer Configuration** (or press CTRL-q) if you haven't already done so.
2. Under **Printer Information**, click on **Wireless General Network**.
3. Set the **IP address method** to **DHCP**.
4. Set the DHCP parameters required for your network by clicking on those options in the **New Value** column.
5. Click the **Send** button to send these changes to the printer.
6. Allow 30 seconds for the printer to reset.

Values obtained from the DHCP server are shown under **Active IP address**, **Active Subnet Mask**, and **Active Gateway**.

Static IP Address

1. Open the NETira CT Printer Configuration Utility Tool and click on **Tools - Query Printer Configuration** (or press CTRL-q) to query the printer.
2. Under **Printer Information**, click on **Wireless General Network**.
3. Change (or confirm) the following parameter settings:
 - **IP address method:** Static
 - **Static IP address:** Set for your network IP range
 - **Static Subnet mask:** Set for your network subnet mask
4. After updating the **New Value** column, click the **Send** button to send this change to the printer.
5. Allow 30 seconds for the printer to reset.

Infrastructure/Ad-hoc

1. Open the NETira CT Printer Configuration Utility Tool and click on **Tools - Query Printer Configuration** (or press CTRL-q) to query the printer.
2. Under **Printer Information**, click on **WIFI**.

3. Change (or confirm) the following parameter settings:
 - **ESSID:** Type the name of your access point (Default = Honeywell)
 - **Network Type:** Infrastructure or Ad-hoc
4. After updating the **New Value** column, click the **Send** button to send this change to the printer.
5. Allow 30 seconds for the printer to reset.

Note: To validate a successful Wireless LAN connection, the IP address obtained from the access point is shown on the printer's LED display.

Wireless LAN Security

The printer can be configured to use several wireless LAN security protocols.

WEP 64 and 128 Bit

1. Open the NETira CT Printer Configuration Utility Tool and click on **Tools - Query Printer Configuration** (or press CTRL-q) to query the printer.
2. Under **Printer Information**, click on **WIFI**.
3. Click on **Static WEP**.
4. Change (or confirm) the following parameter settings:
 - **WEP Selected Key:** Select the key number to use
 - **WEP AP authentication:** If users share 40 bit, use 64 bit encryption. If users share 128 bit, use 128 bit encryption.
 - **WEP Data Encryption:** Enable WEP Data Encryption
 - **WEP Key #1-4:** Enter the WEP keys used by your access point
5. After updating the **New Value** column, click the **Send** button to send this change to the printer.
6. Allow 30 seconds for the printer to reset.

WPA2-PSK with CCMP

1. Open the NETira CT Printer Configuration Utility Tool and click on **Tools - Query Printer Configuration** (or press CTRL-q) to query the printer.
2. Under **Printer Information**, click on **WIFI**.
3. Click on **WPA/WPA2**.
4. Change (or confirm) the following parameter settings:
 - **Group Cipher:** CCMP
 - **Network Authentication Type:** WPA2-PSK
5. Type the pass phrase under **WPA_PSK_TKIP/WPA2_PSK settings**.

6. After updating the **New Value** column, click the **Send** button to send this change to the printer.
7. Allow 30 seconds for the printer to reset.

WPA2-PSK with TKIP

1. Open the NETira CT Printer Configuration Utility Tool and click on **Tools - Query Printer Configuration** (or press CTRL-q) to query the printer.
2. Under **Printer Information**, click on **WIFI**.
3. Click on **WPA/WPA2**.
4. Change (or confirm) the following parameter settings:
 - **Group Cipher:** TKIP
 - **Network Authentication Type:** WPA2-PSK
5. Type the pass phrase under **WPA_PSK_TKIP/WPA2_PSK settings**.
6. After updating the **New Value** column, click the **Send** button to send this change to the printer.
7. Allow 30 seconds for the printer to reset.

WPA2-Enterprise

1. Open the NETira CT Printer Configuration Utility Tool and click on **Tools - Query Printer Configuration** (or press CTRL-q) to query the printer.
2. Under **Printer Information**, click on **WIFI**.
3. Click on **WPA/WPA2**.
4. Change (or confirm) the following parameter settings:
 - **Network Authentication Type:** WPA2-Enterprise
 - **Phase 2 Method:** EAP-MSCHAPv2
 - **EAP Type:** EAP-PEAP
(EAP type can be variable. Other supported types are EAP-LEAP, EAP-TTLS, EAP-PEAP, and EAP-FAST.)
5. Type the user name and password under **WPA/WPA2 Enterprise**.
6. After updating the **New Value** column, click the **Send** button to send this change to the printer.
7. Allow 30 seconds for the printer to reset.

WPA-PSK with TKIP

1. Open the NETira CT Printer Configuration Utility Tool and click on **Tools - Query Printer Configuration** (or press CTRL-q) to query the printer.
2. Under **Printer Information**, click on **WIFI**.

3. Click on **WPA/WPA2**.
4. Change (or confirm) the following parameter settings:
 - **Group Cipher:** TKIP
 - **Network Authentication Type:** WPA-PSK_TKIP
5. Type the pass phrase under **WPA_PSK_TKIP/WPA2_PSK settings**.
6. After updating the **New Value** column, click the **Send** button to send this change to the printer.
7. Allow 30 seconds for the printer to reset.

PRINTER DISPLAY AND BUTTONS

Front Panel

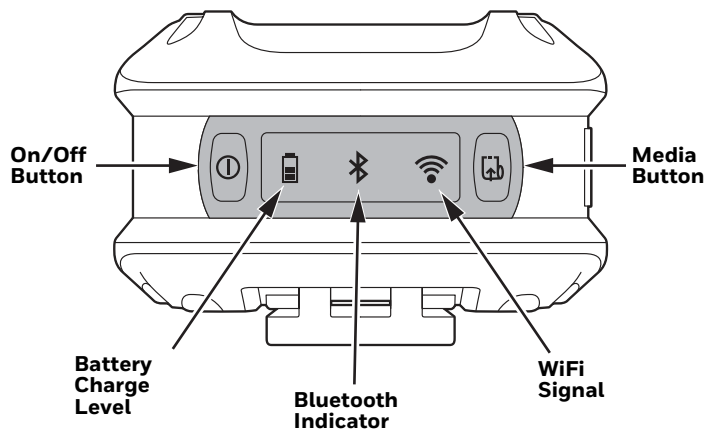

The front panel has an LED display and 2 buttons.

On/Off Button

Button Press	Result
Any length press when printer is off	Turn printer on
Short press (less than 5 seconds)	Enter or exit sleep mode
Medium press (5 - 10 seconds)	Print configuration label (see Print Configuration Label)
Long press (more than 10 seconds)	Turn printer off





Media Button

The media button advances the paper through the printer. When there is no paper in the printer, the button blinks red.

Button Press	Result
Short press	Feeds label or paper length approximately 1 in. (2.54cm) when configured for continuous media. Feeds media to align with the next label when configured for gap or black mark media.
Press and hold for 3 to 4 seconds (when configured for continuous form receipt paper)	Media feeds continuously to the maximum label length

LED Display

If all the LEDs are red and blinking, it indicates it is too warm or cold for the printer to print. See [Product Specifications](#) beginning on page 41 for more information.

Icon	Indication
 On/Off	Solid green = Printer is on Short green flash = Printer is asleep Blinking red = Charger input voltage is too low or too high
 Battery charge level	When not charging: Off = Battery is midway to fully charged Solid orange = Battery charge is 10-30% Blinking red = Battery charge is 10% or less When charging: Solid green = Battery charge is 90% or more Solid red = Battery charge is less than 90%
 Bluetooth indicator	Off = Bluetooth radio is off, disabled, not associated with a mobile device, or printer is off Blinking = Data transmission Solid blue = Bluetooth is enabled and connected
 WiFi signal	Off = WiFi radio is off, disabled, not associated with a mobile device or network, or printer is off White = WiFi is enabled and connected

Audible Indicators

Beeps	Indication
1 long beep	Power supply disconnected
2 short beeps every 5 seconds	No media
2 long beeps	Power supply connected
3 short beeps	Battery charge is low
5 short beeps	Printer door open

Set Sleep and Power Down Timer

The RP Series printer display enters sleep mode after 1 minute of inactivity. Press any button to wake. The printer shuts down after 120 minutes of inactivity unless it is charging. The sleep and shutdown periods can be adjusted or disabled.

1. Turn the printer on and connect it to the computer using the USB cable.
2. Open the NETira™ CT Printer Configuration Utility Tool.
3. Go to **System Settings**, then **Printer Sleep Timeout** to adjust the sleep settings, or **Printer Power Down Timeout** to adjust the shutdown settings.

Real-Time Clock (RTC)

The Real-Time Clock (RTC) is powered from a rechargeable coin cell. Once the RTC is set, and as long as the main battery is in place and has a reasonable charge, the RTC will continue to keep time. If the main battery is pulled, the time setting is retained for 6 months. After 6 months the time will be lost and will need to be reset once power is restored.

Set the Date and Time

1. Open the NETira CT Printer Configuration Utility Tool and click on **Tools - Query Printer Configuration** (or press CTRL-q) to query the printer.
2. Select **Printer Information**.
3. View the current RTC date and time stamp in the **Printer Date Time** section.

To change the date and time:

1. Select **Printer Diagnostics**.
2. Select **Set Date**.
3. Set the date and time fields and click **OK**.

Calibrate the Media

The printer is factory-calibrated for operation with most media types (both gap and reflective). Try your media without performing any calibration adjustments first to determine if the factory settings are compatible. Only perform the calibration adjustments if you are experiencing media-registration issues.

Note: *The battery should be charged to 50% or more before starting media calibration.*

The [Quick Media Calibration](#) should be performed first. If it fails to detect the start of each label properly, proceed to [Manual Media Calibration](#). Install media in the printer before calibrating it.

Note: *Once you have calibrated the printer, you can save this configuration and share it with other users or printers. See [Configuration Files](#) beginning on page 31.*

Quick Media Calibration

1. Turn the printer on. If using a USB interface, connect it to the computer using the USB cable.
2. Open the NETira CT Printer Configuration Utility Tool and click on **Tools - Query Printer Configuration** (or press CTRL-q) to query the printer.
3. In the **Printer Information** column, click on **Sensor Calibration**.

4. Click the **Quick Media** button.

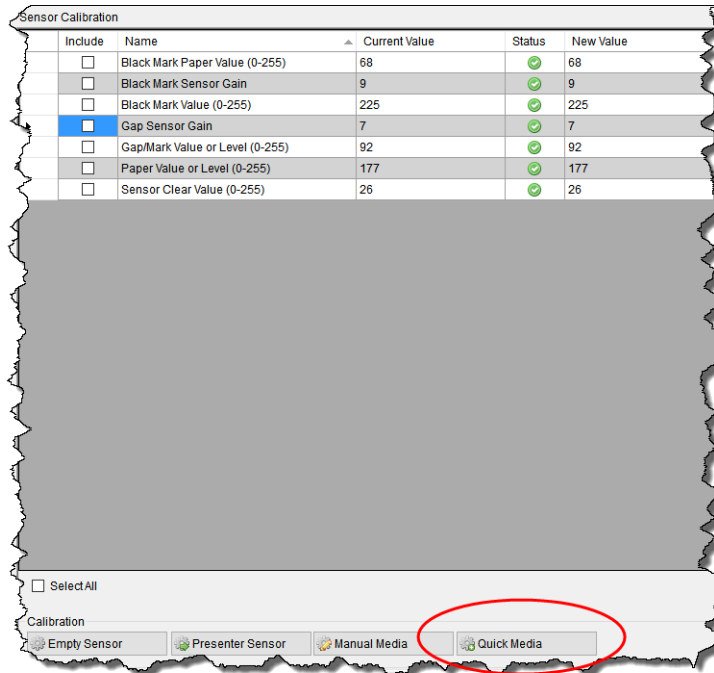

5. The printer feeds media while the sensor is calibrated. If the calibration is not successful, repeat the procedure or use [Manual Media Calibration](#).

Manual Media Calibration

Manual media calibration is used when the Quick Media Calibration has failed to detect the start of each label. This procedure performs a complete recalibration of the sensors and will optimize the printer to your media. In some instances, you may need to perform a Quick Media Calibration after the manual media calibration to further optimize the printer's sensor.

Sensor calibration is needed to set either the black mark or the gap value of the media sensor on the printer.

Gap Type Labels

1. Open the NETira CT Printer Configuration Utility Tool and click on **Tools - Query Printer Configuration** (or press CTRL-q) to query the printer.
2. In the **Printer Information** column, click on **Sensor Calibration**.

3. Click the **Manual Media** button.

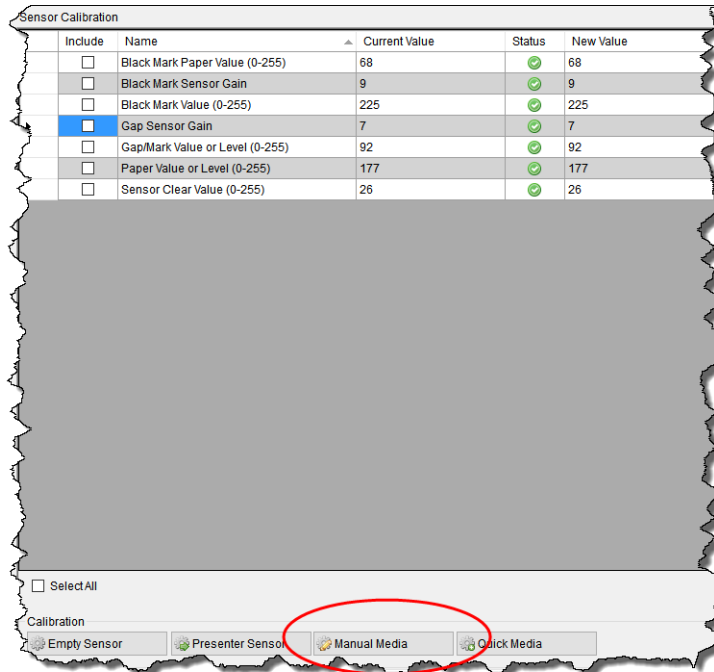

4. When prompted for the media type, select **Interlabel/Gap** and click **OK**.
5. **Load Stock**
 - a. Place the face of the media over the printer's sensor and close the door.
 - b. Click **OK**.
6. **Load Special Backing Media**
 - a. Peel the labels off the backing and place the backing over the printer's sensor.
 - b. Close the door and click **OK**.
7. **Remove Stock**
 - a. Remove all media from the printer and close the door.
 - b. Click **OK**.

If the calibration is not successful, repeat the procedure.

Black Mark Labels

Note: A special media with black marks is necessary to perform this calibration.

1. Open the NETira™ CT Printer Configuration Utility Tool.
2. In the **Printer Information** column, click on **Sensor Calibration**.

3. Click the **Manual Media** button.

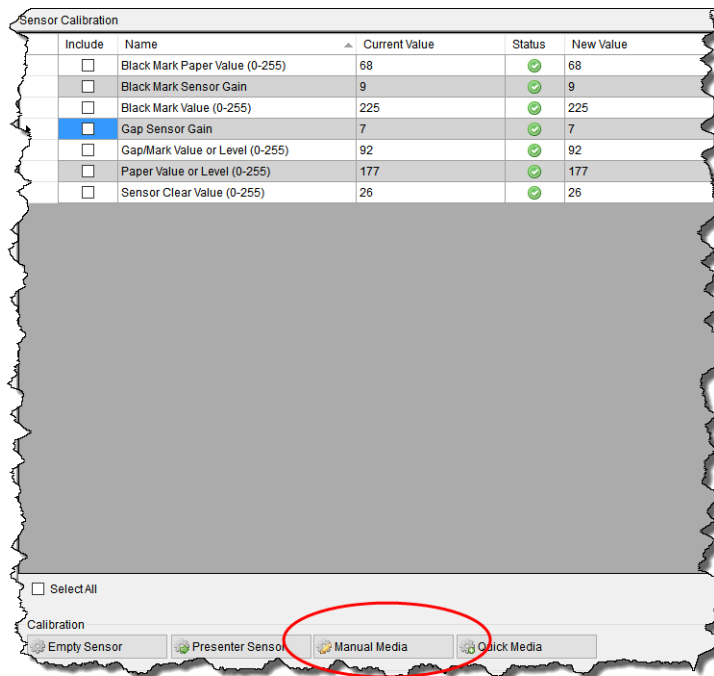

4. When prompted for the media type, select **Black Mark** and click **OK**.

5. Load the media and click **OK**.

If the calibration is not successful, repeat the procedure.

Print Configuration Label

A configuration label provides the firmware version, memory allocations, enabled options, communications settings and label-counter data for the printer. To print

the configuration label, press and hold the power button  for 5 to 10 seconds and then release.

Save and Load Configuration Files

Once you have configured the printer, you can save the configuration and share it with other users or printers.

Save a Configuration File

1. Turn the printer on. If you are using a USB interface, connect the USB cable to the computer.
2. Open the NETira CT Printer Configuration Utility Tool and click on **Tools - Query Printer Configuration** (or press CTRL-q) to query the printer.
3. The current settings (either as-is or with changes you add) can now be saved to a file. Select **File - Save As**.
4. Select a location and name for this configuration file. The file extension is **.cfg**.

Load a Configuration File

1. Turn the printer on. If you are using a USB interface, connect the USB cable to the computer.
2. Open the NETira CT Printer Configuration Utility Tool and click on **Tools - Query Printer Configuration** (or press CTRL-q) to query the printer.
3. Select **File - Open**.

4. Select the .cfg file you want to load.

Note: Check the **Include Sensor Calibration Data on Open** checkbox to import sensor data with the configuration. Sensor data is printer-specific and should only be imported to the same printer from which it came.

Battery Charge Information

Once the battery is at a low charge level, the printer stops printing and queues print jobs. The battery should be replaced at this time so the printer can print the queued jobs. If the battery is not replaced before the supercap is drained, all queued jobs will be lost.

The battery has a test button on it so you can determine how much charge is left.

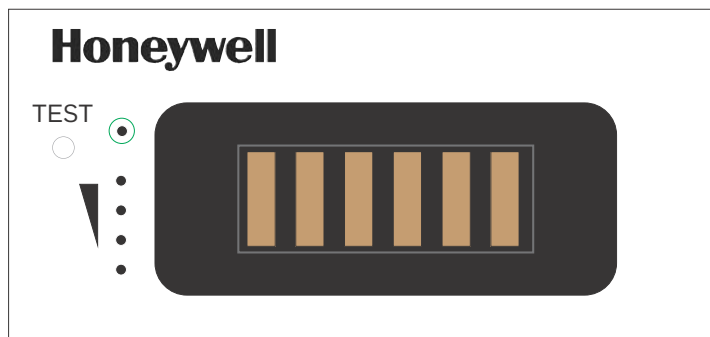

Health Status

Press the test button once quickly. The **Test** indicator (circled in green) lights up to show the health status of the battery.

LED Color	Cycle Count
Green	1 - 400
Amber	400 - 500
Red	500 - 999

Gas Gauge

Press the test button and hold for longer than 5 seconds. The 4 gas gauge lights appear in green to show the amount of charge left in the battery.



Change the Battery

1. Remove the old battery from the printer and reinstall the new battery in the printer.

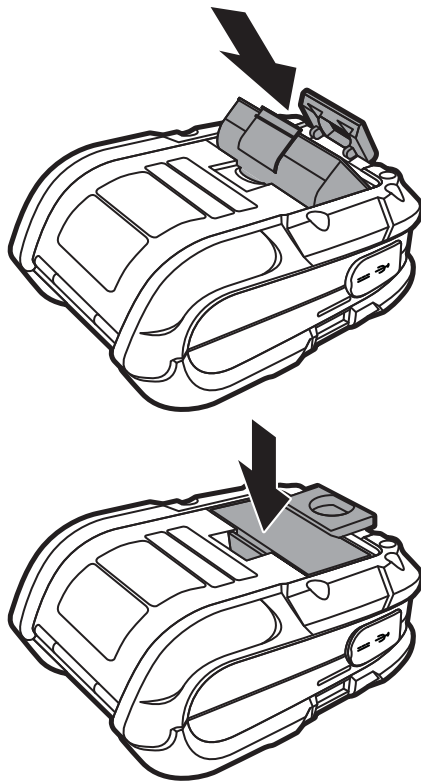

Note: The printer can run for 20 - 120 seconds without a battery and not lose connectivity or need a restart.

2. Connect the power supply to printer's power jack then connect the AC power cord to the power supply. Plug into an outlet.

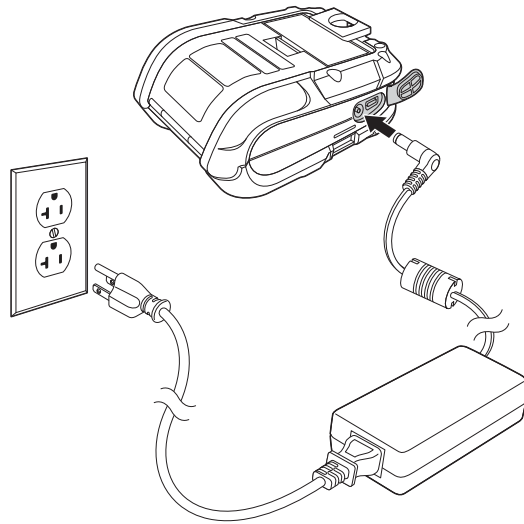

Warning: Do not operate the printer while it is connected to the AC power supply.

Cleaning Intervals

Proper cleaning is critical. To maintain peak performance of the printer, Honeywell offers a complete line of cleaning products, including pens, cards, films and swabs. The following table outlines the recommended maintenance schedule for the various printer parts.

Maintenance Schedule

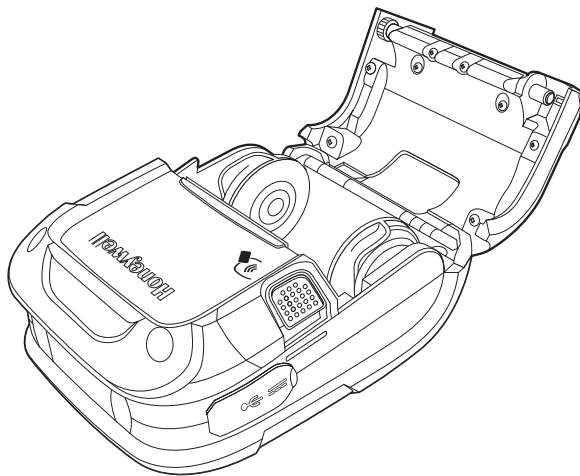

Clean the Printhead

Area	Method (Standard Models)	Method (Linerless Models)	Interval
Printhead	Cleaning card or cotton swab with isopropyl alcohol	Cleaning pens	After 3-5 rolls of media
Platen roller	Cotton swab with isopropyl alcohol	Cleaning pens	After 3-5 rolls of media
Peel off roller	Cleaning pens	Cleaning pens	After 3-5 rolls of media
Lid roller	Cotton swab with isopropyl alcohol	Cleaning pens	After 3-5 rolls of media
Media sensor	Compressed air	Compressed air	Monthly
Interior	Compressed air	Compressed air	As needed

If print quality declines (symptoms include non-compliant bar codes, print drop-outs and streaks), the typical cause is debris buildup on the printhead. When the buildup is not removed it may lead to reduced service life or printhead failure. Streaks in printed labels usually indicate a dirty or faulty printhead.

Standard RP4 Models

Clean the printhead using a cleaning card:

1. Open the printer and remove all media.
2. Open the fan fold door in the bottom of the printer.
3. Insert the cleaning card through the door and close the printer cover.
4. Press the Media Feed button several times to feed the cleaning card through the printer. Repeat if necessary.
5. Reload media and close the printer.
6. Press the Media Feed button to feed the media through.

Linerless Models

Cleaning pens are used on linerless-model printers or any printer with adhesive buildup. They are used to clean components that are exposed directly to adhesive.

- Step 1. Rub this pen along the sticky component to break down the adhesive buildup.
- Step 2. Rub this pen along the component to remove the buildup.

The pen cap has a plastic scraper that can be used to remove large amounts of adhesive buildup.



Caution: Do not use on the platen roller or sensors.

Firmware Update

When program updates and/or new features are added, they can be downloaded to the printer.

1. Identify the new version for your printer model from www.honeywellaidc.com and download it to your computer.
2. Turn the printer on and connect it to the computer using the USB cable.
3. Open the NETira CT Printer Configuration Utility Tool.

Note: NETira CT must be version 1.0.0.92 or higher.

4. Query the printer by clicking **Tools - Update Available Connections For Printer**. This will look for the USB Virtual COM Port.

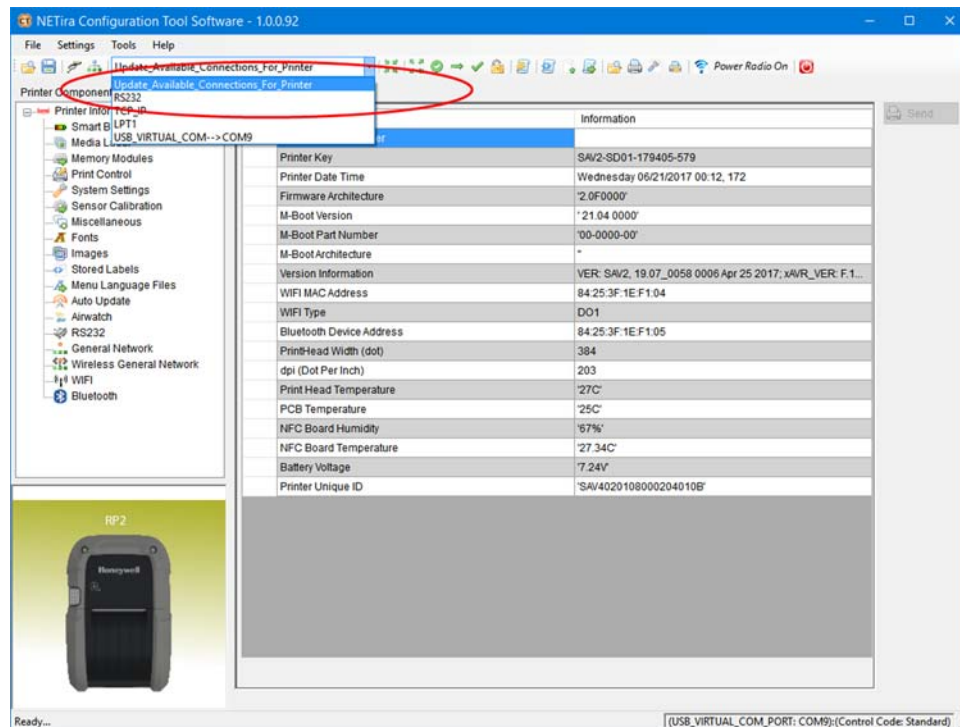

5. Once this is completed, reopen the dropdown menu and select the USB Virtual COM port.
6. Select **Tools - Query Printer Configuration** (or press CTRL-q) to display the printer's configuration.

7. Select **Tools - Update Printer via File Streaming Method.**

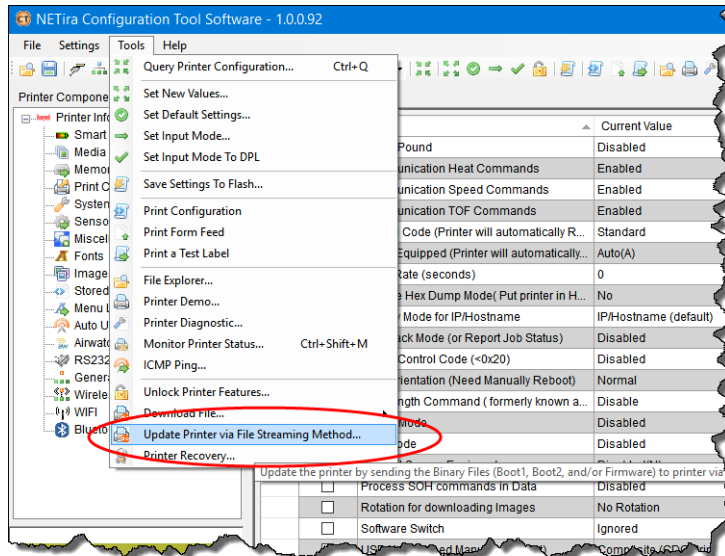

8. Click **OK** to continue.

9. Click on the button for **Application Mode.**

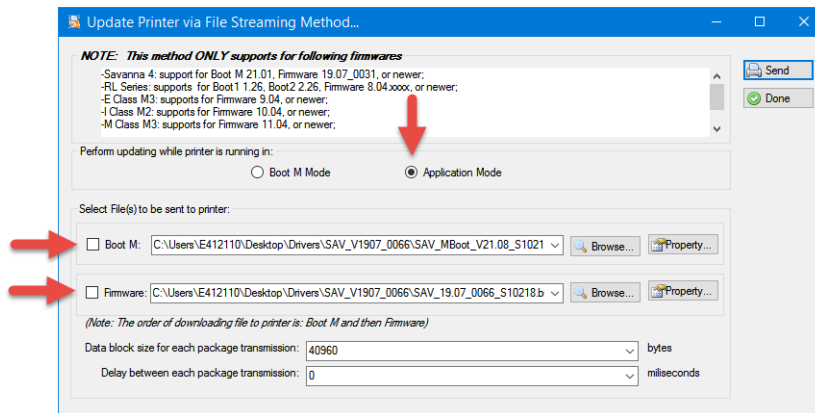

10. Click on the checkboxes for **Boot M** and for **Firmware** and browse to the locations of these files.

11. Click the **Send** button to start the download.

The Bluetooth, WiFi, and Media Feed buttons on the printer flash slowly, then quickly. Once the buttons stop flashing and the power light is solid green, the printer is ready for normal operation.

Once you have corrected any of the following problems, press the media button



to clear the alarm.

Print quality is bad

- Clean the printhead (see [Clean the Printhead](#) on page 36).
- The temperature setting may be incorrect for the media being used. Use the NETira CT Printer Configuration Utility or software commands to adjust the heat setting and print speed.
- The printhead may be faulty. Call for service (see [Product Service and Repair](#)).

Printer indicates it is out of media, even though it is not

- The printer sensor may have accumulated paper dust. Clean the sensor with compressed air.

Printer doesn't print or prints several labels at once

- The labels are incorrectly loaded. See [Load the Media](#).
- The media is not calibrated. See [Calibration](#).
- The media sensor or sensor circuitry may be defective. Call for service (see [Product Service and Repair](#)).

Printer skips every other label or occasionally skips labels

- The label is formatted too close to the top edge of the label. Leave white space equal to 8-dot rows, about .02 inch (.5mm) at the top of the label.
- The media is not calibrated. See [Calibration](#).
- The media sensor or media-sensor circuitry may be defective. Call for service (see [Product Service and Repair](#)).

Unable to print rotations

- The characters are formatted outside the dimensions of the label. Check that the row and column values provide enough room for the height of the image being printed.

Printing is light on the right side of the label

- The printer's cover is not latched down. Latch it.
- The printhead is not properly aligned. Call for service (see [Product Service and Repair](#)).

Printer fails to power on

- The battery may need to be charged. Charge the battery (see [Charge the Battery](#)).

Label advances 8 inches before a fault indication

- The media may not be properly loaded. See [Load the Media](#). When loading media, make sure the supply hubs are against the media and that gaps or marks in the labels are in line with the media sensor.
- The media sensor or media-sensor circuitry may be defective. Call for service (see [Product Service and Repair](#)).

Labels move excessively from side to side during printing

- The media may not be properly loaded. See [Load the Media](#). When loading media, make sure the supply hubs are against the media and that gaps or marks in the labels are in line with the media sensor.

RP2 Printer Specifications

RP2	
Parameter	Specification
Mechanical	
Height	3 in. (77mm)
Length	6.3 in. (160mm)
Width	4.6 in. (116mm)
Weight (printer and battery only)	1.58 lbs. (0.72kg)
User Interface	
Buttons	2
Electrical	
DC Input Smart Battery External DC Jack and External Charge Contacts	9.5-14V, built-in spike and surge protection
Battery	
Lithium Ion	8.4V 2600 mAHr minimum
Endurance	Prints more than 320 4"x6" (102 x 152 mm) labels when operating 16 continuous hours
Expected Charge Time	4-6 hours
Communication	
USB Interface	2.0 (full speed)
Bluetooth Interface Versions	4.1 LE, Class 2, Serial-port profile iOS certified
Wireless LAN Network Standard Wireless Access Modes	IEEE 802.11 a/b/g/n/ac with Dual Radio Infrastructure and ad-hoc

RP2	
Parameter (Continued)	Specification
Security Protocols	WEP (64/128), WPA (TKIP/RC4), WPA2 (CCMP/AES)
Authentication	LEAP, EAP-PEAP, EAP-FAST, EAP-TTLS, EAP-LEAP
Network Support	DHCP, TCP, UDP, DNS, BOOTP
Print Technology	
Print Head	Direct thermal, 203 DPI
Print Width	2.8 in. (71.1mm)
Print Speed	4 in. (102mm) per second
Memory	
Installed Memory	64 MB RAM/2 GB Flash
Media	
Media Roll Width	1 - 2.25 in. (25- 57mm)
Maximum Print Width	1.89 in. (48mm)
Maximum Roll Capacity	2.25 in. (58mm) outside diameter
Core Sizes	0.4 in. (10.16mm), 0.75 in. (19mm), or 1 in. (25.4mm) inside diameter
Media Thickness	2 - 6.3 mil (.05 - .16mm)
Environmental	
Temperature Ranges:	
Operating	-4°F to + 131°F (-20°C to 55°C)
Storage	-22°F to + 149°F (-30°C to 65°C)
Charging	32°F to + 104°F (0°C to 40°C)
Humidity	Up to 10-90% non-condensing
Mechanical Drop	Operational after 50 drops from 6.6 feet (2m) to concrete
ESD Sensitivity	15 kV direct air 8 kV contact
IP Rating	IP54 dust and water

RP4 Printer Specifications

RP4	
Parameter	Specification
Mechanical	
Height	3 in. (77mm)
Length	7.36 in. (187mm)
Width	6.46 in. (164mm)

RP4	
Parameter (Continued)	Specification
Weight (printer and battery)	2.25 lbs. (1.02kg)
Weight (printer only)	1.72 lbs. (0.78kg)
User Interface	
Buttons	2
Electrical	
DC Input Smart Battery External DC Jack and External Charge Contacts	9.5-14V, built-in spike and surge protection
Battery	
Lithium Ion	8.4V 4900 mAHr minimum
Endurance	Prints more than 960 4"x6" (102 x 152 mm) labels when operating 8 continuous hours
Expected Charge Time	4-6 hours
Communication	
USB Interface	2.0 (full speed)
Bluetooth Interface Versions	4.1 LE, Class 2, Serial-port profile iOS certified
Wireless LAN Network Standard Wireless Access Modes Security Protocols Authentication	IEEE 802.11 a/b/g/n/ac with Dual Radio Infrastructure and ad-hoc WEP (64/128), WPA (TKIP/RC4), WPA2 (CCMP/ AES) LEAP, EAP-PEAP, EAP-FAST, EAP-TTLS, EAP-LEAP
Network Support	DHCP, TCP, UDP, DNS, BOOTP
Print Technology	
Print Head	Direct thermal, 203 DPI
Print Width	4.1 in. (104.8mm)
Print Speed	Up to 5 in. (127mm) per second in draft mode
Memory	
Installed Memory	64 MB RAM/2 GB Flash
Media	
Media Roll Width	2 - 4.4 in. (51 - 111mm)
Maximum Print Width	4.1 in. (104mm)
Maximum Roll Capacity	2.25 in. (58mm) outside diameter
Core Sizes	0.4 in. (10.16mm), 0.75 in. (19mm), or 1 in. (25.4mm) inside diameter
Media Thickness	2 - 6.3 mil (.05 - .16mm)

RP4	
Parameter (Continued)	Specification
Environmental	
Temperature Ranges:	
Operating	-4°F to + 122°F (-20°C to 50°C)
Storage	-22°F to + 149°F (-30°C to 65°C)
Charging	32°F to + 104°F (0°C to 40°C)
Humidity	Up to 10-90% non-condensing
Mechanical Drop	Operational after 50 drops from 6.6 feet (2m) to concrete
ESD Sensitivity	15 kV direct air 8 kV contact
IP Rating	IP54 dust and water

Required Safety Labels

RP2Printer

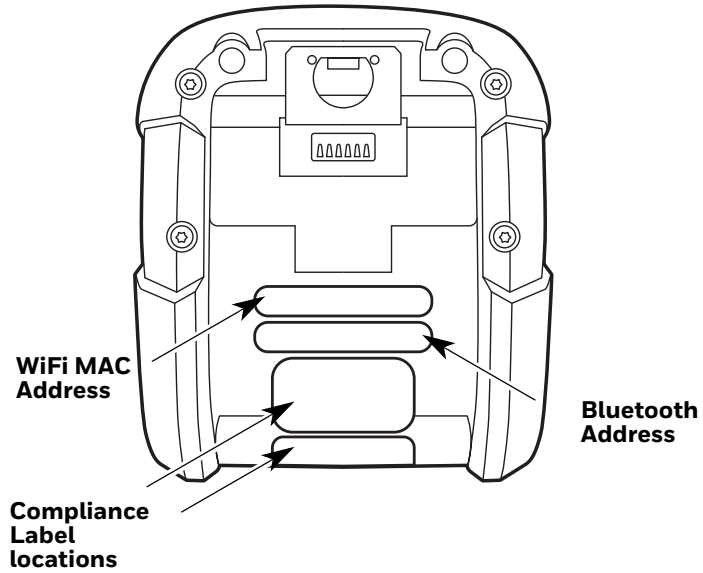

RP4Printer

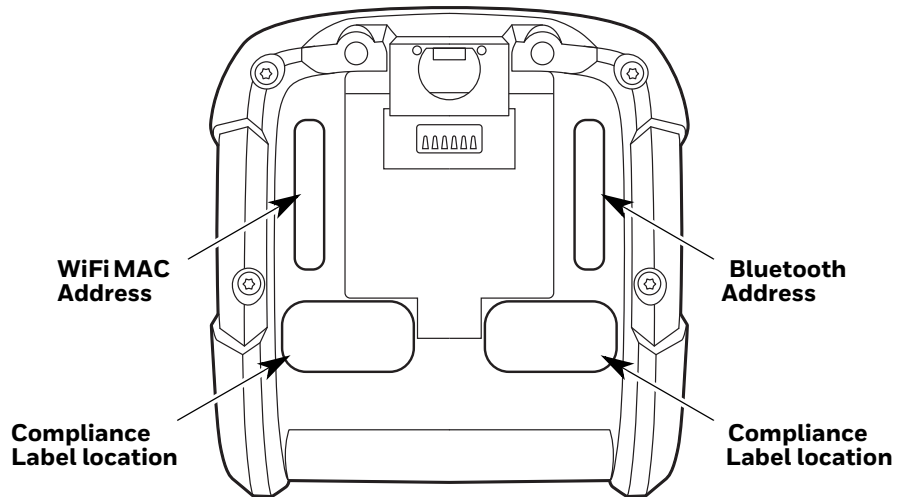

Fonts

10 alphanumeric fonts from 2.5 to 23 point, including OCR-A and OCR-B.

Bar Code Symbologies

Linear: Codabar, Code 3 of 9, Code 93, Code 128, EAN-8, EAN13, Interleaved 2 of 5, HIBC, Plessey, MSI, UCC/EAN-128, UPC-A, UPC-E, UPC 2 and 5-digit addendums, Postnet, Telepen, MaxiCode, FIM, USD-8.

2D Symbologies: PDF417, Aztec, QR Code, GS1, Data Matrix, TCIF Linked Code 39, MicroPDF417

Graphics

Graphics, including transient “print once” graphics, and logos are stored in flash memory.

Software and Firmware

NERira Configuration Tool for complete printer setup.

Control Language Compatibility

Line Printer Mode, Easy Print, DPL, ZPL II®, CPCL, IPL™, XML (limited)

Device Management Support and Compatibility

NETira

NETira MD: mobile device management utility for smart mobile devices

AirWatch® Mobile

Wavelink® Avalanche MC

Soti Mobilink

Network Compatibility

TCP/IP-based networks, AS/400 (LPD)-based networks

O/S Support

Microsoft® Windows® XP, Vista, 7, 8, and 10

Label Design Software Compatibility

BarTender®, Niceware/NiceLabel

ERP Systems

SAP®, Oracle®

Software Development Kit

Android™ 4.0 and above

Apple iOS 5,6, and 7

Microsoft® Windows desktop up to Windows® 8, Windows® 8 Store, Windows® Mobile and Windows® CE

C++, C Sharp, Java™, ActiveX Control

Belt Clip

The belt clip is included with your printer. The nub attachment allows the printer to swivel for comfort when you are bending over or getting in and out of vehicles.



Shoulder Strap/Hand Strap (RP4 Printer Only)

Each hand or shoulder strap incorporates heavy-duty clasps for an easy and secure attachment, however, these are not OSHA-approved safety straps.

Both the hand strap and shoulder strap have a limited breakaway strength. If the strap is caught or wrapped and pulled beyond normal use the strap will come off the attachment points. Do not use the straps for mounting, hanging or as the means for a permanent installation of the printer. If the latch appears damaged (white stress marks in the plastic) discontinue use and replace.

Belt Loop

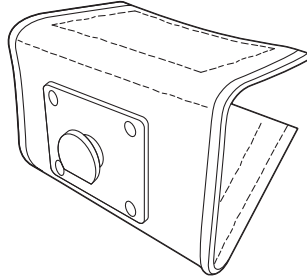

The Velcro® loop fastens comfortably and securely around your belt and keeps the printer secure. The nub attachment allows the printer to swivel for comfort when you are bending over or getting in and out of vehicles.

Soft Case



Proper use of this case will allow the printer to be used in harsh, dusty, or rainy environments. This case will protect your product against particles as small as dust, and water from any direction. This case can be used in conjunction with the hand/shoulder straps as well the belt-loop and belt-clip accessories.

The soft case is not designed for extensive prolonged use in the rain. Do not allow water to enter the case when changing media.



Caution: Excessive water inside the printer, even if a soft case is used, may violate your warranty.

1. Slide the printer into the case, then close the case using the 2 side zippers and Velcro® closure.
2. Fold back the paper exit flap for each print job. The paper exit flap can also be rolled up out of the way and secured using the Velcro® strip. Doing so decreases the effectiveness of the case for water protection.

Never attempt to charge when the printer case or printer is wet since a short circuit could occur. Remove the printer from the case, allow to completely dry, and then charge. In the event water is believed to have entered the printer, remove the battery and allow the unit to dry for several days before installing the battery or charging.

USB On-the-Go

The RP2 or RP4 printer can act as a host so another device such as a bar code reader, USB flash drive, or keyboard can be added. Contact your Sales Representative for a USB On-the-Go cable.

PRINTER LANGUAGE EMULATION

The RP2, RP3, and RP4 printers support several printer languages, such as CPCL, ZPL, and DPL. The printers default to auto input mode that detects the type of script, then switches to the desired printing language. The following instructions guide you through manually changing the printer language.

Note: You should only select up to 2 printer languages. You may experience unintended results if you select more than 2.

1. Open the NETira CT Printer Configuration Utility Tool and click on **Tools - Query Printer Configuration** (or press CTRL-q) to query the printer.
2. Go to **Tools - Set Input Mode**.

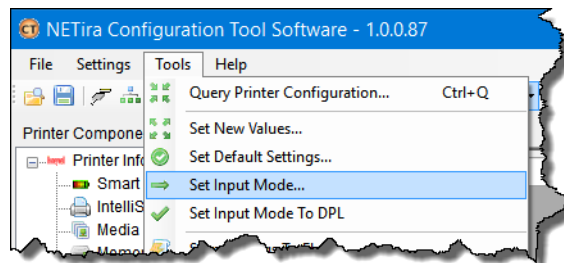

3. Select the desired printer language from the dropdown. Click **Set** and **Done**.
4. Click the **Send** button to send this change to the printer.

Allow 30 seconds for the printer to reset.

Note: The NETira CT Configuration Utility can only communicate with the printer using the DPL printer language input mode. Once the printer has been set to use an input mode other than DPL, the printer's input mode must be changed back to Auto or DPL when you need to communicate with the NETira CT.

You can send demo label formats to the printer either using Netira CT.

NETira CT Printer Demo

1. Open the NETira CT Printer Configuration Utility Tool and click on **Tools - Query Printer Configuration** (or press CTRL-q) to query the printer.
2. Go to **Tools - Printer Demo**.
3. Browse to the folder containing the print files. Highlight the files to be printed and click **Add**.
4. Click **Print** to send the files to the printer.

Honeywell
9680 Old Bailes Road
Fort Mill, SC 29707

www.honeywellaidc.com