

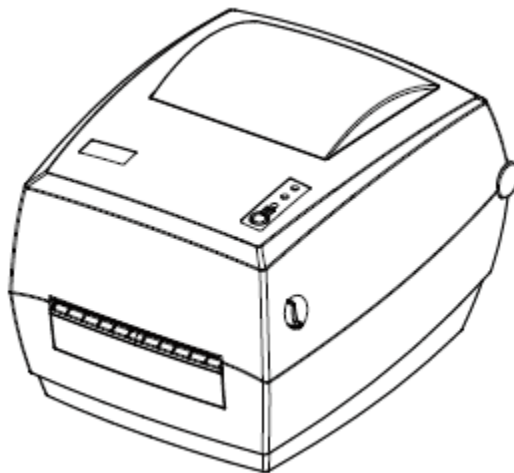

*Let Things Better
Faster and Vital*

SP420



User Manual

Customer Service Email: support@idprt.com

Web: www.idprt.com

Contents

Important Safety Instructions.....	1
Chapter 1 Introduction	4
1.1 Packing List	4
1.2 Appearance and Components.....	5
1.3 Dimension.....	6
Chapter 2 Specifications	7
Chapter 3 Installation & Usage.....	8
3.1 Media Loading	8
3.1.1 Paper Roll Loading.....	8
3.1.2 External Paper Roll Loading.....	10
3.2 Power Connection	11
3.3 Peripherals Connection	12
3.3.1 Interface Cable Connection	12
3.4 Operation Panel.....	13
3.4.1 Button Operation	13
3.4.2. Description of Indicator Status:.....	13
3.5 Basic Operation	14
3.5.1 Power on/Power off	14
3.5.2 Feed Button	14
3.5.3 Quick Calibration	14
3.5.4 Printing Self-test Page	15
Chapter 4 USB Interface	16
Chapter 5 Maintenance & Adjustment	17
5.1 Cleaning Media Sensor.....	17
5.2 Cleaning Thermal Print Head	17
5.3 Cleaning Roller and/or Paper Path	18
Chapter 6 Label Printer Utility Instructions.....	19
6.1 Installation Preparation	19
6.2 Usage	19
Chapter 7 Windows Driver Instructions	27
7.1 Introduction.....	27
7.2 Installation Preparation.....	27
7.3 Installation	28
7.4 Usage	31



*Let Things Better.
Faster and Vital*

7.4.1 Printing Preferences	31
7.4.2 Printer Properties	40
7.5 Removing.....	44

■ Statement

This manual content may be changed without permission and our company reserve the rights to make changes in technology, spare parts, hardware and software of the products. Please contract our company, if the user need further information about the products. Without any written permission from our company, any section of this manual is prohibited to be copied or transferred in any form.

■ Copyright

This manual is printed in 2021, the copyright belongs to Xiamen Hanin Electronic Technology Co. Ltd.

Printed in China

1.0 Version

■ Warnings



This must be complied with in order to avoid damage to the human body and the equipment.



This shows the important information and tips for the printer operation.

■ Attention

Due to continuous improvement of the products, the specifications, accessories and procedures described in the manual are based on actual machines. And it may be changed without prior notice.

Important Safety Instructions

Before using the printer, please read carefully the following safety consideration in case of bodily injury or equipment damage.

1. Safety warning



The print head will become very hot during printing, please do not touch the printhead and peripheral parts during printing and printing just finished.



Please do not touch the printhead and connectors, in case that static damages the printer head.

2. Instructions



Warnings: Violating following instructions may cause serious injury or death.

- 1) Do not plug several products in one porous power outlet.
 - This may cause over-heat and a fire.
 - If the plug is wet or dirty, dry or wipe it before using.
 - If the plug does not fit perfectly to the outlet, do not plug in.
 - Be sure to use only standardized porous power outlet.
- 2) You must use the supplied adapter.
 - It is dangerous to use other adapters.
- 3) Do not pull the cable by pulling.
 - This may damage the cable or cause a fire.
- 4) Do not plug in or unplug with your wet hands.
 - You may be electrocuted.
- 5) Do not bend the cable by force or leave it under any heavy object.
 - A damaged cable may cause a fire.



Note: Violating following instructions may cause slight damage of the appliance.

- 1) If you observe a strange smoke, odour or noise from the printer, unplug it before taking following measures.
 - Switch off the printer and unplug the set from the mains.
 - After the disappearance of the smoke, call your dealer to repair it.
- 2) Install the printer on the stable surface.
 - If the printer falls, it may be broken and you may hurt yourself.
- 3) Use the approved accessories only and do not try to disassemble, repair or remodel it by yourself.
 - Call your dealer when you need these services.
 - Do not touch the blade of auto cutter.
- 4) Do not let water or other foreign objects drop into the printer.
 - If this happened, switch off and unplug the printer before calling your dealer.
- 5) Do not use the printer when it is out of order. This can cause a fire or an electrocution.
 - Switch off and unplug the printer before calling your dealer.
- 6) Other considerations:
 - Place the printer on a solid and even base so that it cannot fall.
 - Leave enough space around printer for operation and maintenance.
 - Keep all liquids away from the printer.
 - Do not expose the printer to high temperatures, direct sunlight or dust.
 - Ensure the printer is connected to a socket with the correct mains voltage.
 - Switch off the printer POWER supply when it's not in use for a long time.
 - To ensure the printing quality and reliability, suggest use the same quality or recommend paper supplier.
 - Pls. switch off the POWER supply when connect/disconnect all the ports or it will cause damage to the printer control circuit.
 - Never carry out maintenance or repair work yourself. Always contact a qualified service Technician.
 - Keep this User Manual in a place which is always easily accessible.

3. Other Precautions

The copyright for this user manual and various other manuals is property of our company. Any copying or conversion into electronic form and saving of this material without the express written permission is strictly prohibited. Use of the information contained in this manual is not subject to any patent liability. This manual has been prepared with utmost care and attention to detail but may contain certain errors and/or omissions. Our company is not legally liable for any damages resulting from the use of the information in this manual. Our company and its affiliates are not legally liable (United States excluded) for any damages, loss, costs, and/or expenses that result from the breakdown, malfunction, and/or misuse of the product due to violation or neglect of the operation and maintenance information and instructions provided by our company, as well as from the unauthorized alteration, repair, and/or modification of the product by the user and/or third party. We are not legally liable for any damages and/or issues resulting from the use of options and/or parts that are not authentic or authorized products.

4. WEEE (Waste Electrical and Electric Equipment)



This mark shown on the product or its literature indicates that the corresponding item should not be discarded at the end of its working life with other household waste. To prevent possible harm to the environment or human health from uncontrolled waste disposal, please separate marked items from other types of waste and recycle them responsibly to promote the sustained reuse of material resources. Household users should contact either the retailer where they purchased this product, or their local government office for details of where and how they can conduct environmentally safe recycling of such items. Commercial users should contact their suppliers and check the terms and conditions of purchase contracts. This product should not be combined with other commercial waste for disposal.



Caution: This is a Class A product. In a domestic environment this product may cause radio interference in which the user may be required to take adequate measures.

Chapter 1 Introduction

1.1 Packing List



Note:

1. Unpack the printer and keep the packing materials in case you need to ship the printer in the future.
2. Any damages exist, please contact the local dealer.



Printer



Power Cord



USB Cable



AC Adapter



User Guide



CD



Label



Note: The packing items are based on the order.

1.2 Appearance and Components

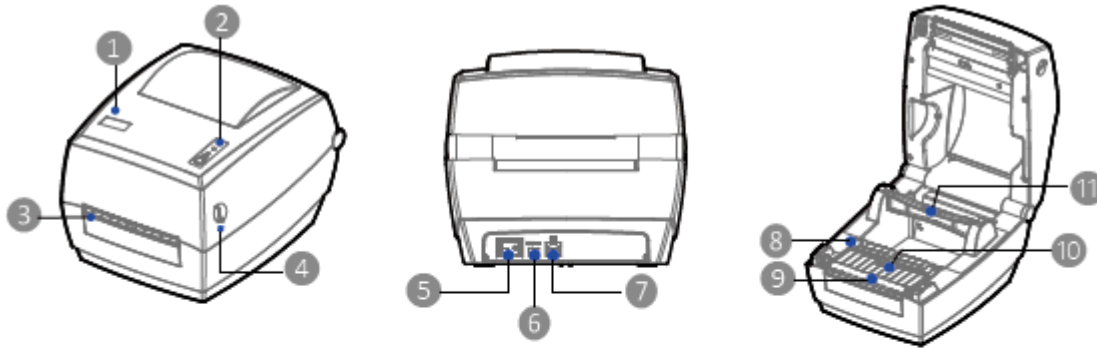

- 1 Top Cover
- 2 Feed Button
- 3 Paper Outlet
- 4 Cover Open Levers
- 5 Power Switch
- 6 Power Receptacle
- 7 USB Port
- 8 Moveable Label Guides
- 9 Platen
- 10 Paper Sensor
- 11 Print Head Module



Note: The views above are for your reference. Ports vary by your choice.

1.3 Dimension

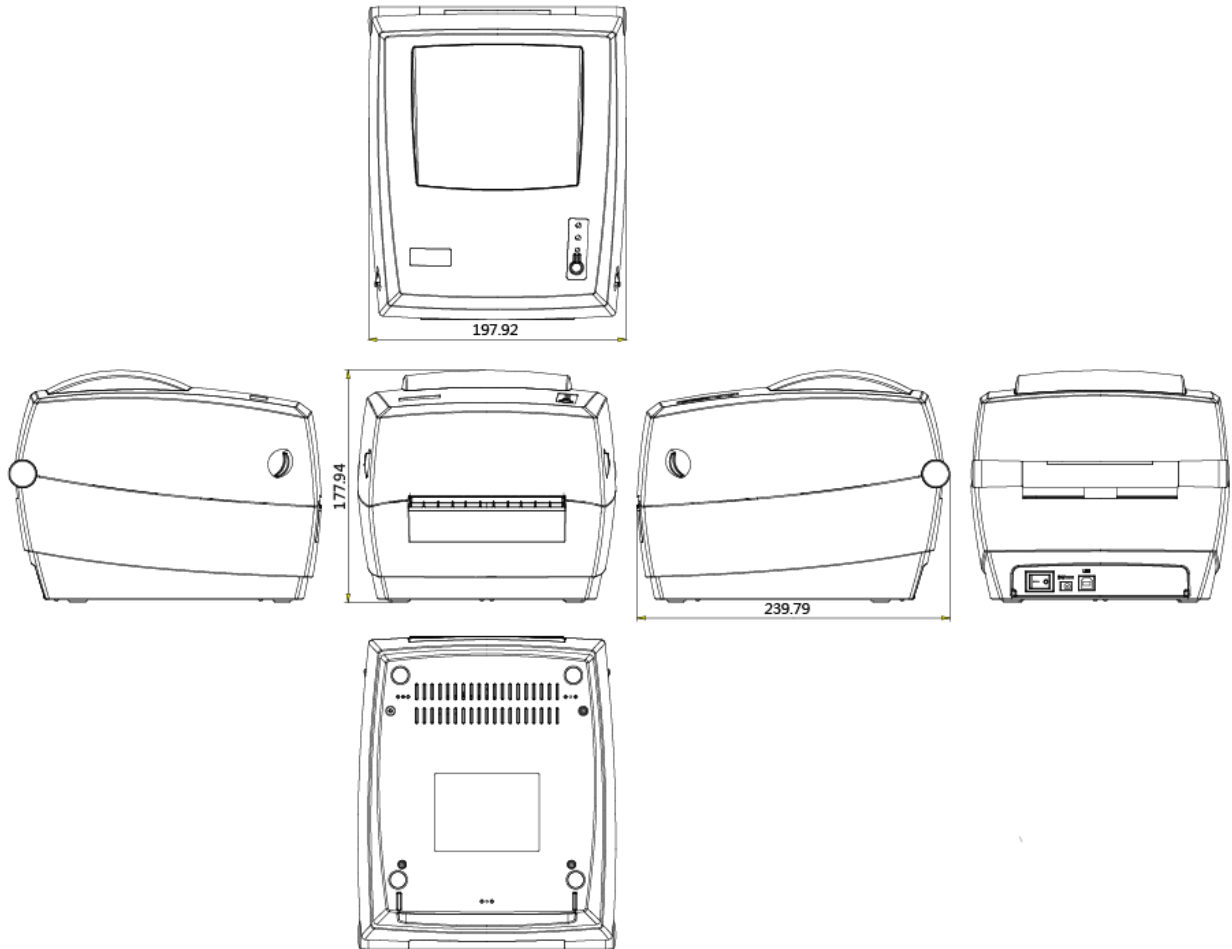

Unit: mm

Chapter 2 Specifications

Items		Parameter
Printing	Printing Method	Direct thermal
	Resolution	203dpi(8dots/mm)
	Printing Speed	50/75/100/125/150 mm/s
	Printing Width	50-108mm
	Printing Length	25mm - 300mm
Processor		32 bits RISC CPU
Memory	RAM	2MB
	Flash	2MB
Detection	Sensors	Paper out detection, seam label detection, black mark detection, open detection
Media	Types	Roll-fed or fan-fed, label paper, black mark paper
	Width	2"(50mm) – 4.65"(118mm)
	Thickness	0.003"(80um) – 0.007"(180um)
	Ext. Label Roll Diameter	5"(127mm)
	Ext. Fan-fold Paper	W:100mm x L:100mm- 300mm
Programming Language		TSPL, EPL
Software	Label Design Software	BarTender
	Driver	Windows, Mac OS, Linux
Resident Fonts		GBK 16x16 24x24dots ASCII 8x16, 12x24dots
Barcode	1D	Code 39, Code 93, EAN 8/13 (add on 2 & 5), UPC A/E (add on 2 & 5), I 2 of 5, Codabar, Code 128 (subset A, B, C)
	2D	QR Code
Communication Interfaces		USB
Man-machine interface		Indicator: Red, Green
Power		I/P: AC100-240V, 50/60Hz, O/P: DC 24V/2.5
Environment	Operation	41°F (5°C)-104°F (40°C), %-85%,non-condensing
	Storage	-4°F (-20°C)-122°F (50°C), %-90%,non-condensing
Physical	Dimension	240*178*198mm(L*W*H)
Characteristics	Weight	2.26kg, excluding consumables
Options & Accessories		External label roll holder Folding carton
Agency Approvals		CCC

Chapter 3 Installation & Usage

3.1 Media Loading

3.1.1 Paper Roll Loading

1. Press the left and right cover open lever with hands simultaneously and lift the printer cover.



2. Hold the paper roll shaft and take out of the printer.



3. Load paper into paper roll shaft coordinate the inside diameter.

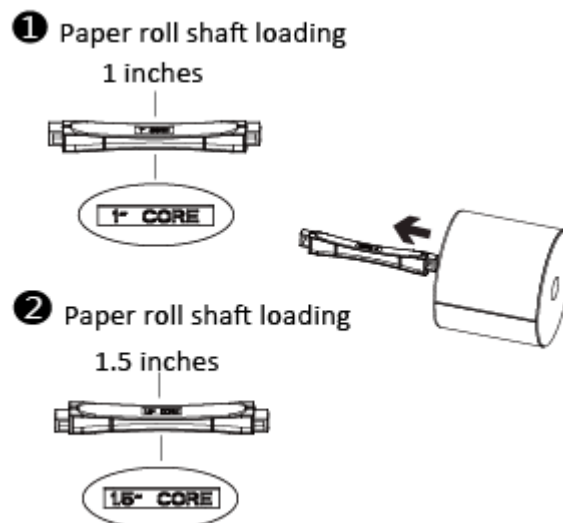

4. Then load the paper module from the top down to printer.

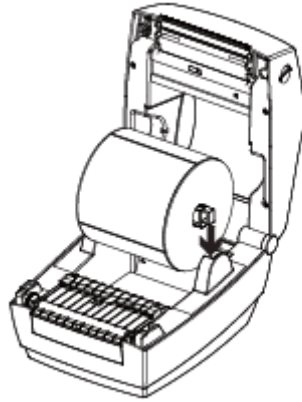

5. Pull some paper and pass it through paper guides, adjust paper guides according to the paper width.

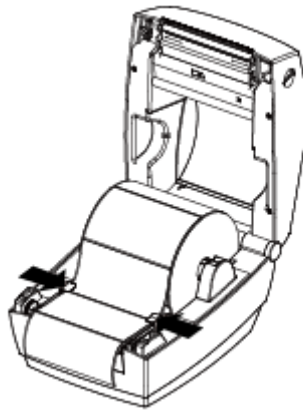

6. Press down the top cover until it closes.



Note: If your printer is under Thermal Line Printing Method, press down the printer cover until it snaps closed. Otherwise, continue the procedure in chapter 3.1.2.

3.1.2 External Paper Roll Loading

If the paper roll is extremely large, users can load the paper roll outside (See the graph at right). Pass the paper through the external feed slot and then through the paper guides.

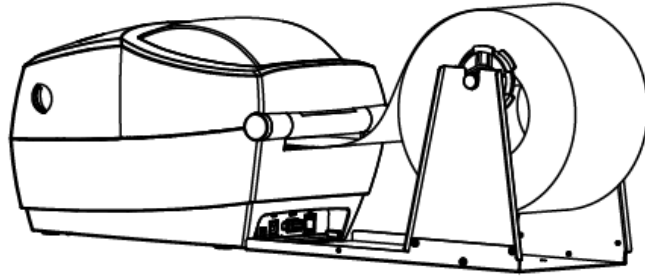

Note: the paper roll holder can be fixed on the clamping pin on both sides.

3.2 Power Connection

1. Make sure the printer's power switch is in the off position.
2. Connect the AC adapter to printer.
3. Connect the power cord to AC adapter.
4. Connect the other end of power cord to the outlet.

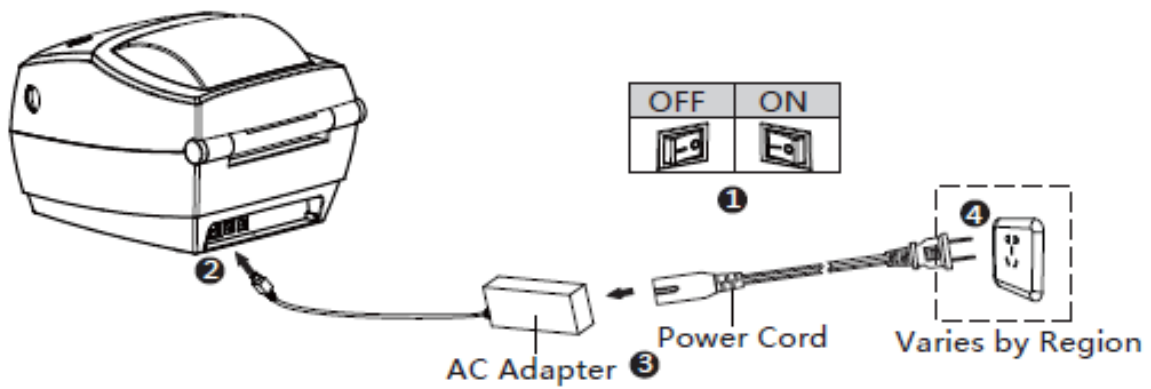

NOTE:

- Use the original power adapter only, in case that the damage caused by charging improperly.
- Please unplug the printer power cord if it is not in use for a long time.

3.3 Peripherals Connection

3.3.1 Interface Cable Connection

The standard for the printer's interface cable shows in the following.

-- USB B-Type Cable

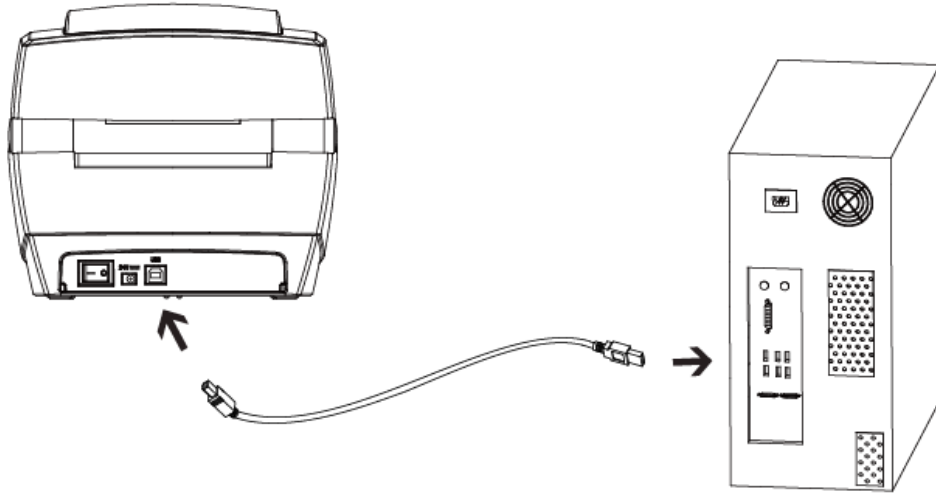

- 1) Turn off the power switch.
- 2) Connect the communication cable to the printer communication port to be used.
 - Connect USB B-Type cable to the USB port.

3.4 Operation Panel

3.4.1 Button Operation

■ Power On

When power off, turn on the power switch at the back of printer, then the indicator will light on.

■ Power Off

When power on, turn off the power switch at the back of printer, then the indicator will light off.

■ FEED button

Press the FEED button, and printer will feed paper to the specified position according to the paper type. Just long-press the FEED button once that will feed the fixed distance paper when using continuous paper. Long-press FEED button once that will feed a whole label paper when using label printer.

3.4.2. Description of Indicator Status:

Be Ready		Status		Description
Color	Action	Color	Action	
Green	Light	X	X	The printer is ready
Green	Flash Slowly	X	X	Pause
X	X	Red	Light	The position switch not in place
X	X	Red	Flash Fast	The label learning is abnormal
X	X	Red	Flash Slowly	Label positioning is abnormal
X	X	Yellow	Flash Slowly	Paper jam, label positioning is abnormal

3.5 Basic Operation

3.5.1 Power on/Power off

Press “O” to power off the printer. Press “I” to power on the printer.

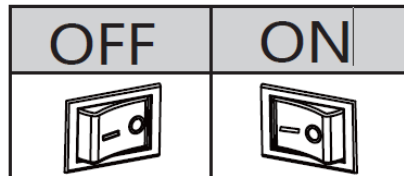

3.5.2 Feed Button

Press the FEED button, and printer will feed paper to the specified position according to the paper type. Just long-press the FEED button once that will feed the fixed distance paper when using continuous paper. Long-press FEED button once that will feed a whole label paper when using label printer.

3.5.3 Quick Calibration



Note: users must carry out the calibration under the conditions below:

- The first time to use the printer after installation;
- The first time to use the printer since sensor cleaning;
- Reuse the printer when it has not been used for a long time;
- Change a new type of media;
- Printer cannot recognize the mark;
- Huge change of the operating environment;

Calibration method:

1. Carry out the calibration manually.

When the printer is ready, press the FEED button until the status indicator (green) flashes twice. Then release the button, and printer will start to do the calibration. Loosen the FEED button of printer until the status indicator (Green) flash twice, then it starts to the black label mode learning. When printer start the calibration under the continuous media mode, the calibration is invalid.

2. Carry out the calibration by printer utility tool.

Please refer to detailed information in “Chapter 6 Label Printer Utility Instructions”.



Note: after the calibration, users could open the printer cover to pull back the learned paper in avoid of paper wasting.

3.5.4 Printing Self-test Page

The self-test checks the printer's current settings, status and whether the printer has any problems or not.

1. Printing Manually

- 1) Make sure the roll is loaded properly.
- 2) Make sure the top cover and mechanism of the printer are closed properly. Then turn on the printer.
- 3) When the printer is ready, press the feed button continuously. As soon as the indicator flashes (blue) once, loosen the button. Then the printer starts to print the self-test page.

2. Printing by Windows Driver Program

- 1) Install the Windows Driver program.
- 2) Please set the "Interface" as the type you use.
- 3) Use the Windows Driver Program to print out the "Self-test page".
- 4) Please refer to "Chapter 7 Windows Driver Instructions" for more detailed information.

Chapter 4 USB Interface

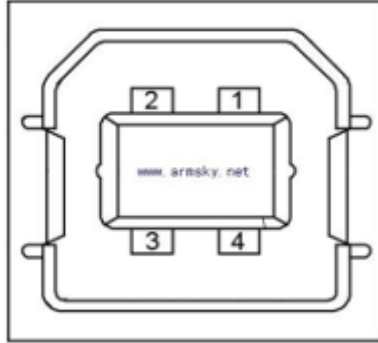

PIN	SIGNAL NAME
1	VBUS
2	D-
3	D+
4	GND

Chapter 5 Maintenance & Adjustment

Adhesives and coatings of the media can transfer to the printer parts over time along the media path including the thermal print head and media sensor. This build-up can accumulate dust and debris. Failure to clean the print head, media path, and media sensor could result in inadvertent loss of labels, label jams and possible damage to the printer.



Note:

- Make sure to turn off the printer prior to cleaning.
- As the print head gets hot during printing, if intending to clean the print head, turn the printer off and wait approximately 2~3 minute before commencement.
- When cleaning the print head, take care not to touch the heated portion of the print head. Print Head is susceptible to damage from static electricity, etc. It is strongly recommended to wear hand gloves during cleaning progress.
- Take care not to allow the print head become scratched and/or damaged in any way.

5.1 Cleaning Media Sensor

Debris or dirt on the paper sensor can cause a miss-read or unstable detection of the label gap. Clean with a cotton bud dampened with alcohol.

5.2 Cleaning Thermal Print Head

Thermal Paper stock on the print head, which degrades print quality. Clean the print head with methanol or isopropyl alcohol and a cotton bud. Do not touch the heating elements with your fingers.

- 1) Open the Printer Cover and then use the cleaning pen to clean the head in the direction from the center of the head to two sides.
- 2) After cleaning the head, do not use the printer until the alcohol used for cleaning evaporates completely (1~2 min) and the printer has completely dried.
- 3) Perform the cleaning process each time the paper roll is replaced to prevent print quality deterioration.

5.3 Cleaning Roller and/or Paper Path

- 1) Open the printer cover and then remove the paper.
- 2) Remove any dust or foreign substance using dry cloth or cotton swab.
- 3) Soak the cloth or cotton swab in alcohol for medical use and use it to remove adhesive foreign substances or other pollution materials.
- 4) After cleaning the parts, do not use the printer until the alcohol evaporates completely (1~2 min) and the printer has completely dried



Note: Clean the parts when print's quality or label detection degrades.

Chapter 6 Label Printer Utility Instructions

6.1 Installation Preparation

Download IDPRTUtilityForLabel application program. e.g.: IDPRT Print Utility For Label V2.0.0.0.

6.2 Usage



Note: The screen may vary slightly by different operating systems and models. Following takes SP420 (Windows 7) for example.

(1). Open the “IDPRTUtilityLabel”.

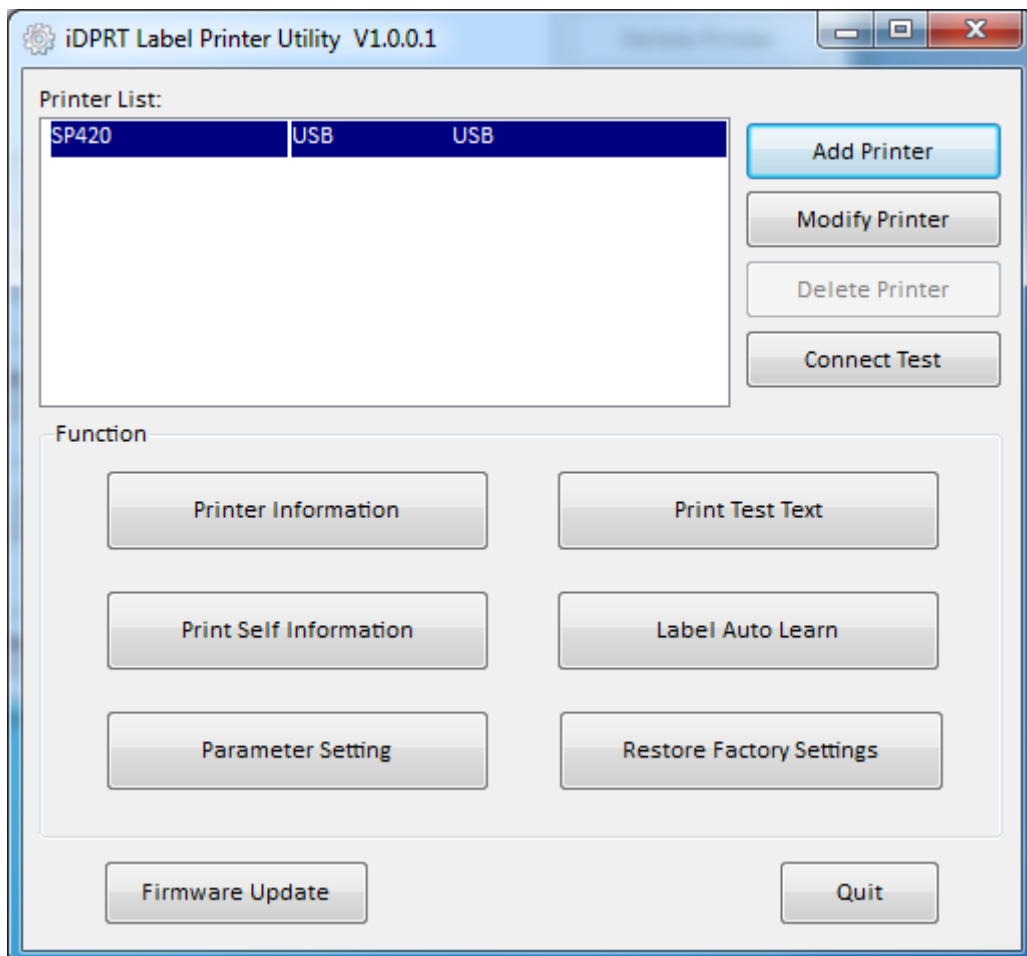

(2). Add/Modify/Delete Printer, Connect Test.

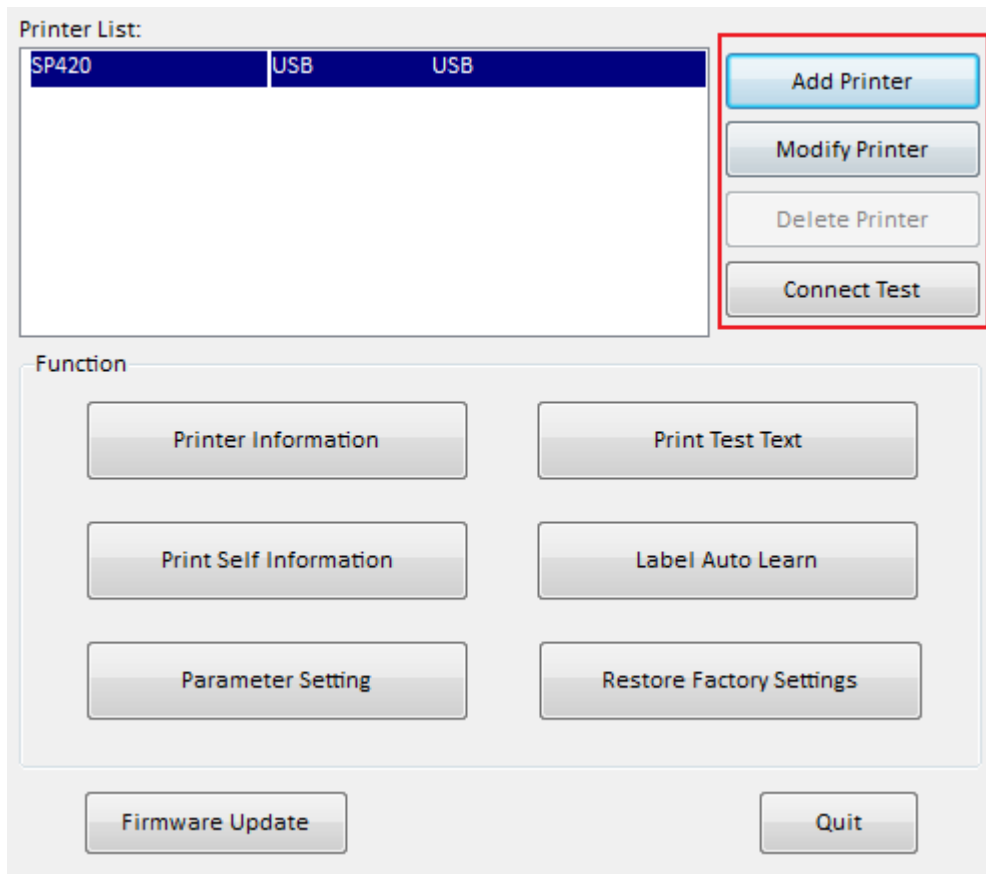

- Click "Add Printer" to choose the printer and port (take USB for example), click "OK" and add successful.

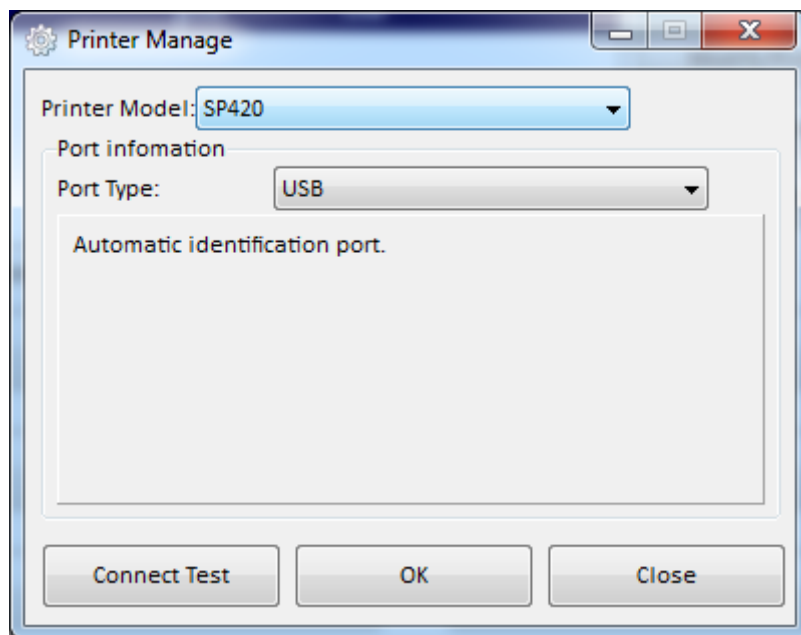

- Click “Delete Printer”, click “OK” to delete the printer.

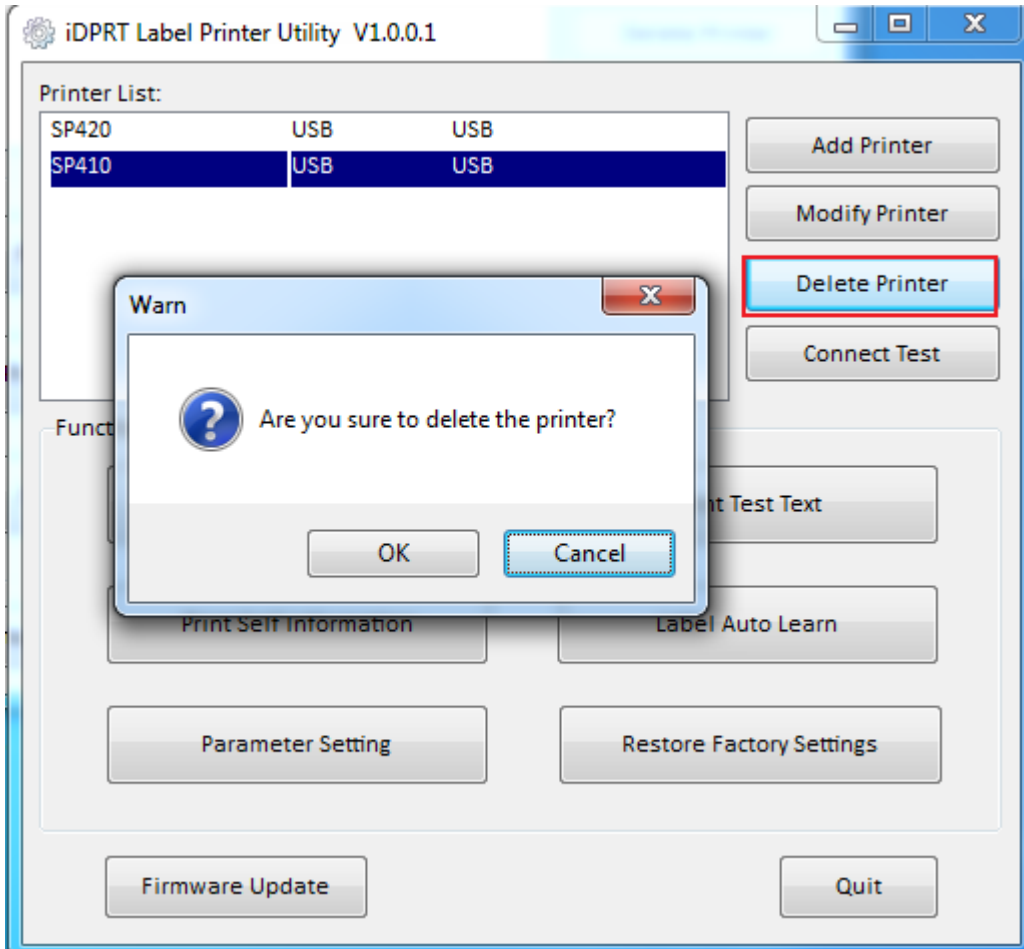

- Choose the printer currently use, connect it to computer. Click “Connect Test” to test whether the connection is ok or not.

If connection is OK, the icon below will come out.

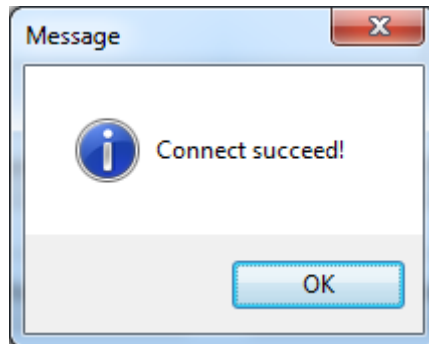

If connection fails, normally shows following icon.

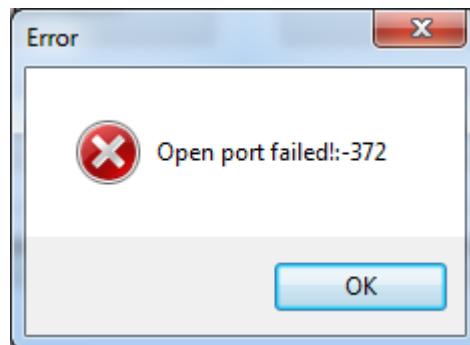

Note: Please connect your printer to power firstly, choose one port (depend on the printer you bought) to connect to the PC. Connecting method refer to the Power Connection. When connection fails, please check the connection or whether the port matches. (When USB port is used, it is better to make sure only one printer is connected)

(3).Function.

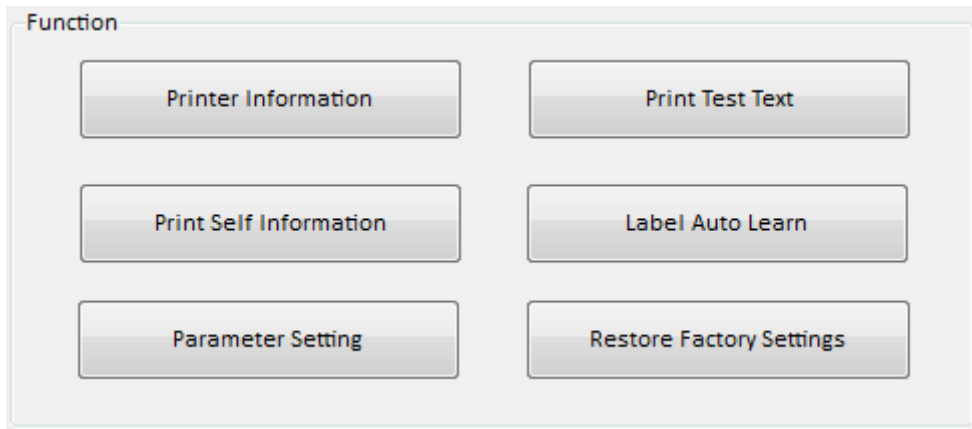

- Click "Printer Information" to check the printer information. (Depend on your printer)

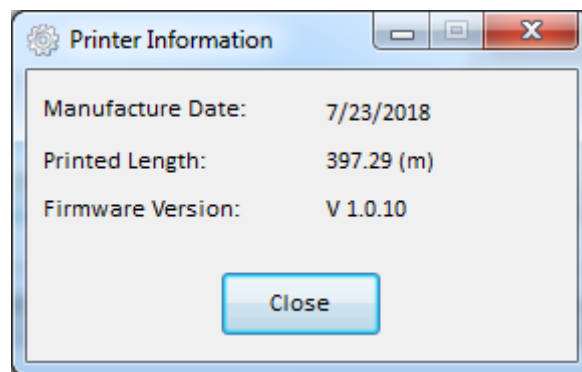

- Click "Print Test Text", input the text you need to print. Set up the printing range (printable width & height). Click "Print" and the printer starts to print the text.

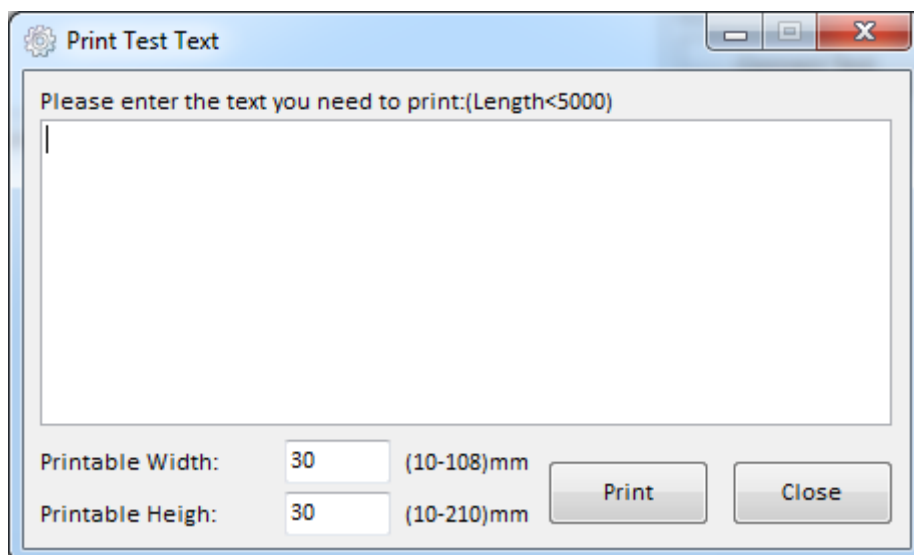

- Click “Print Self Information”, then printer starts to print self-test page.

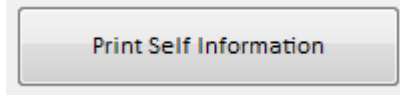

- Click “Label Auto Learn”, then printer will carry out the calibration.



- Click “Parameter Setting”.

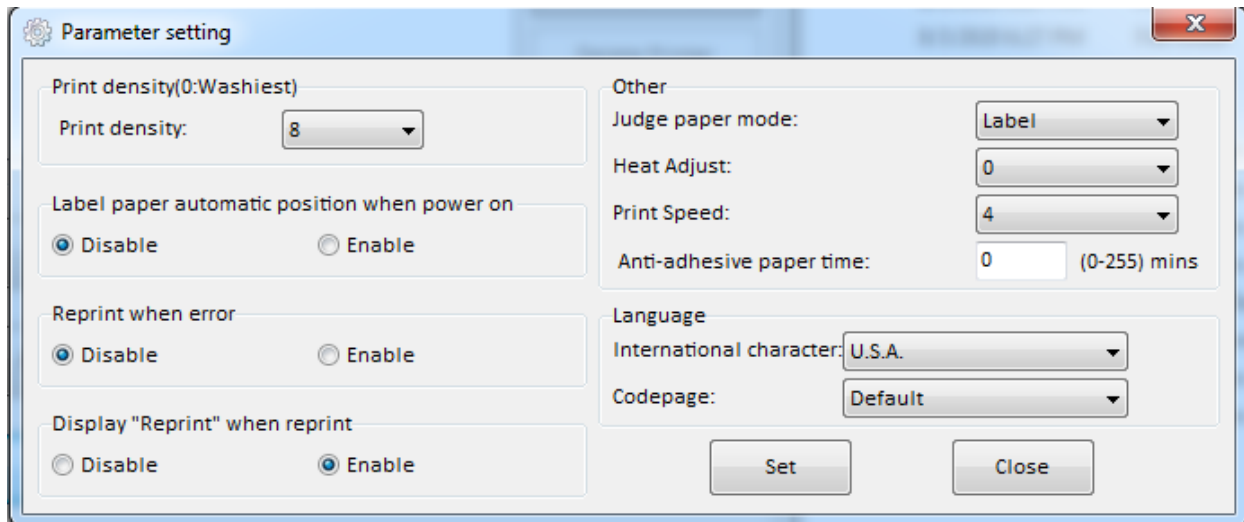

- 1) Print density (choose range:0~15):

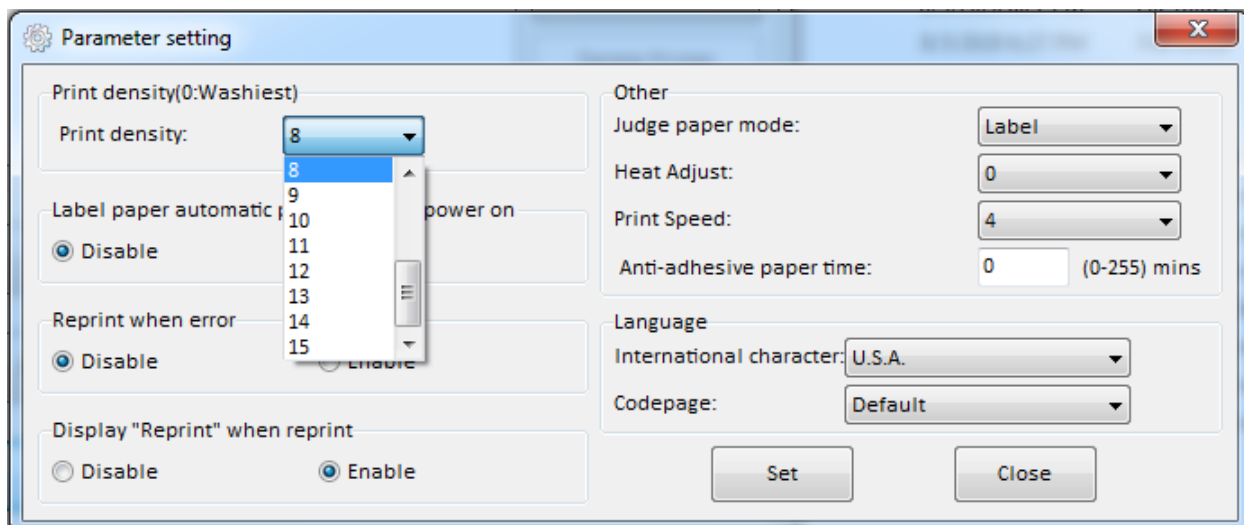

2) Judge Paper Mode (Label, Receipt, Blackmark):

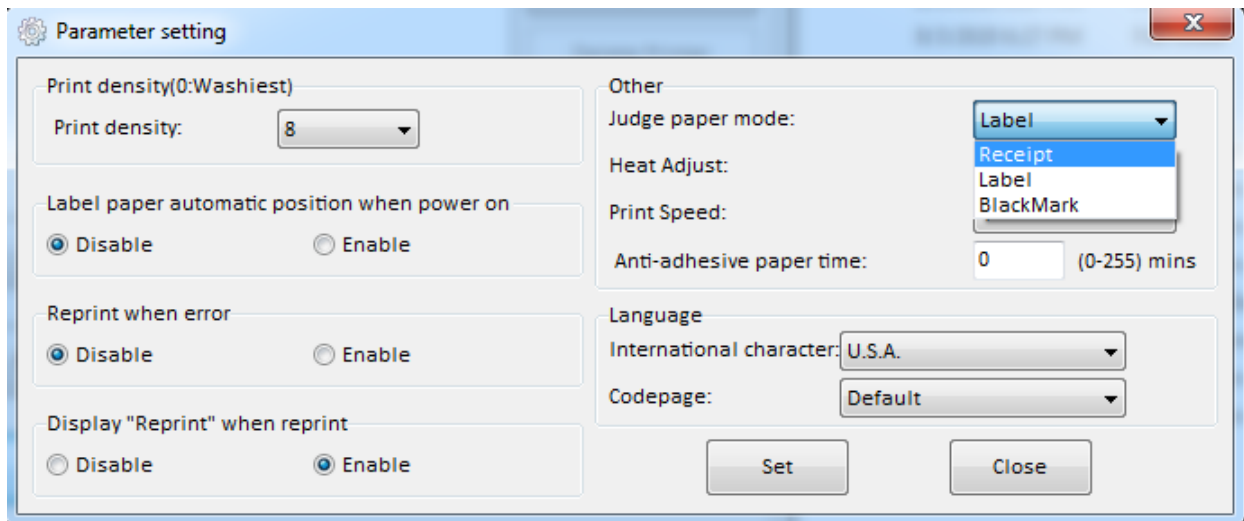

3) Heat Adjust (Range: -50~50):

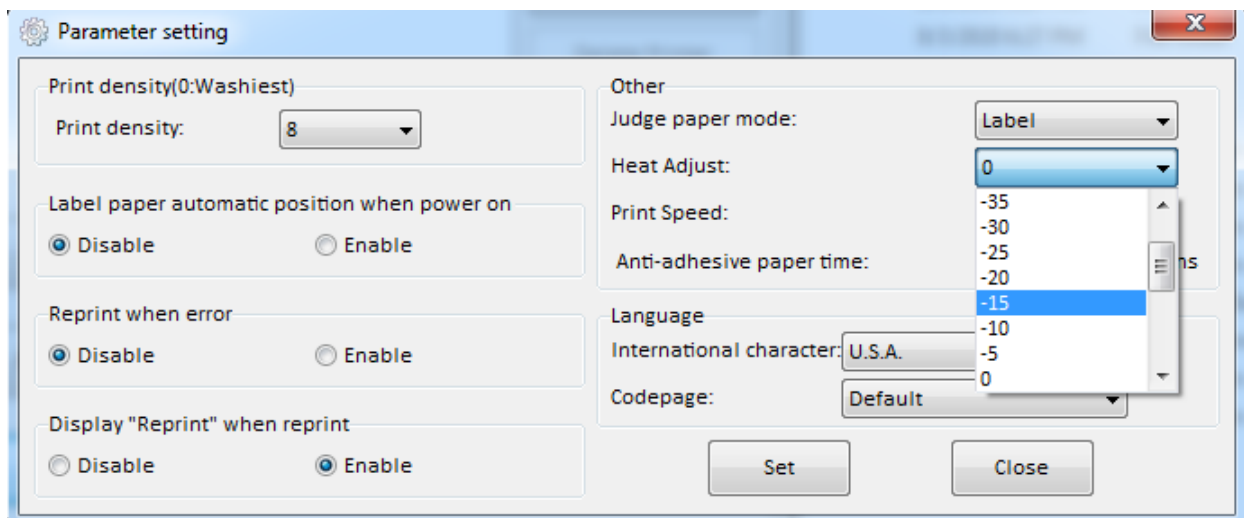

4) Print Speed (Range: 2,3,4):

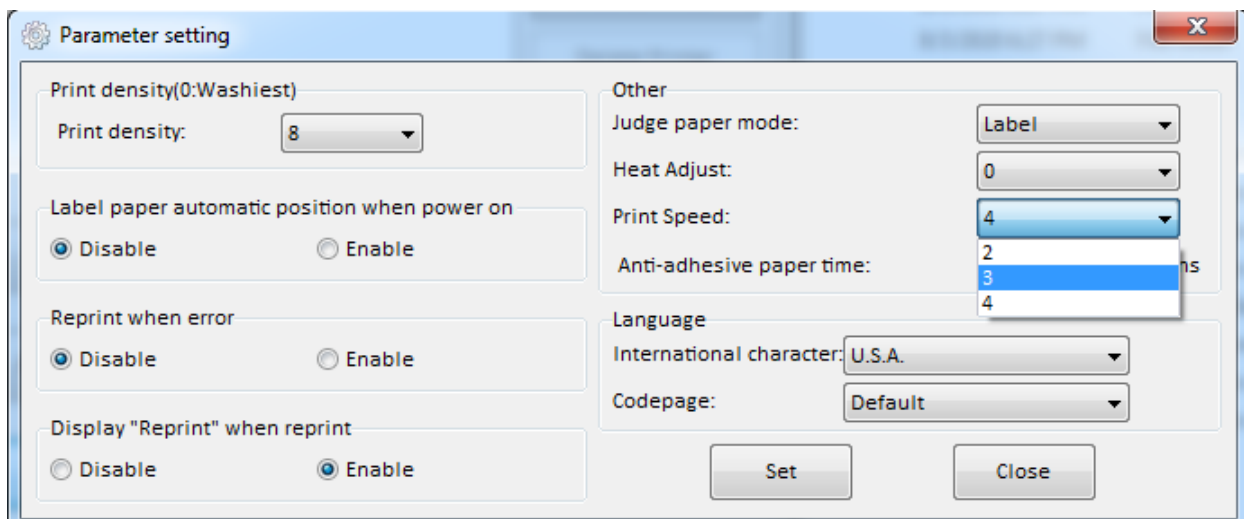

5) Click “Set” save all the above settings, click “ok” back to the main menu.

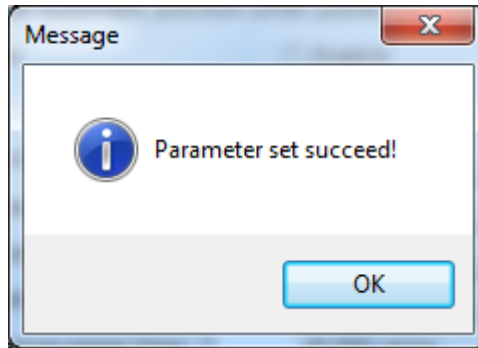

6) Click “Close” back to the main menu.

●Click “Restore Factory Settings”, click “OK” to restore factory settings, click “Cancel” to cancel the restore factory settings.

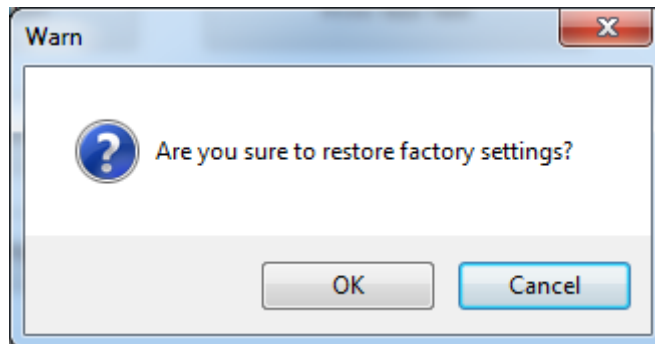

(4). Click “Quit”, finish printer settings.

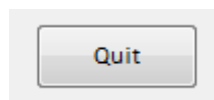

Chapter 7 Windows Driver Instructions

7.1 Introduction

This chapter provides information on installation according to PC operating system (OS).

This driver support for these following operating systems:

Microsoft Windows 10 (32 bit/64 bit)

Microsoft Windows 8 (32 bit/64 bit)

Microsoft Windows 7 SP1 (32 bit/64 bit)

Microsoft Windows Vista SP2 (32 bit/64 bit)

Microsoft Windows XP SP2

Microsoft Windows 2000

Microsoft Windows Server 2012 (64 bit)

Microsoft Windows Server 2008 R2

Microsoft Windows Server 2008 SP2 (32 bit/64 bit)

Microsoft Windows Server 2003 R2 SP2 (32 bit/64 bit)

7.2 Installation Preparation

Download Windows Driver application program. Latest version please see our website:
www.idprt.com.

7.3 Installation



Warning: There are some differences under different operating system. Please operate it according to the tips. Recommend to close security software before installation in case of preventing installation.

1. Select one interface to connect your printer to computer.
2. Turn on the printer check if it is connected to computer successfully.
3. Double click Windows Driver.

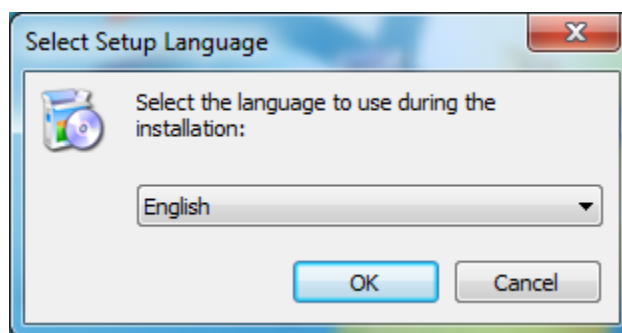

4. After agree to the EULA, click "Next".

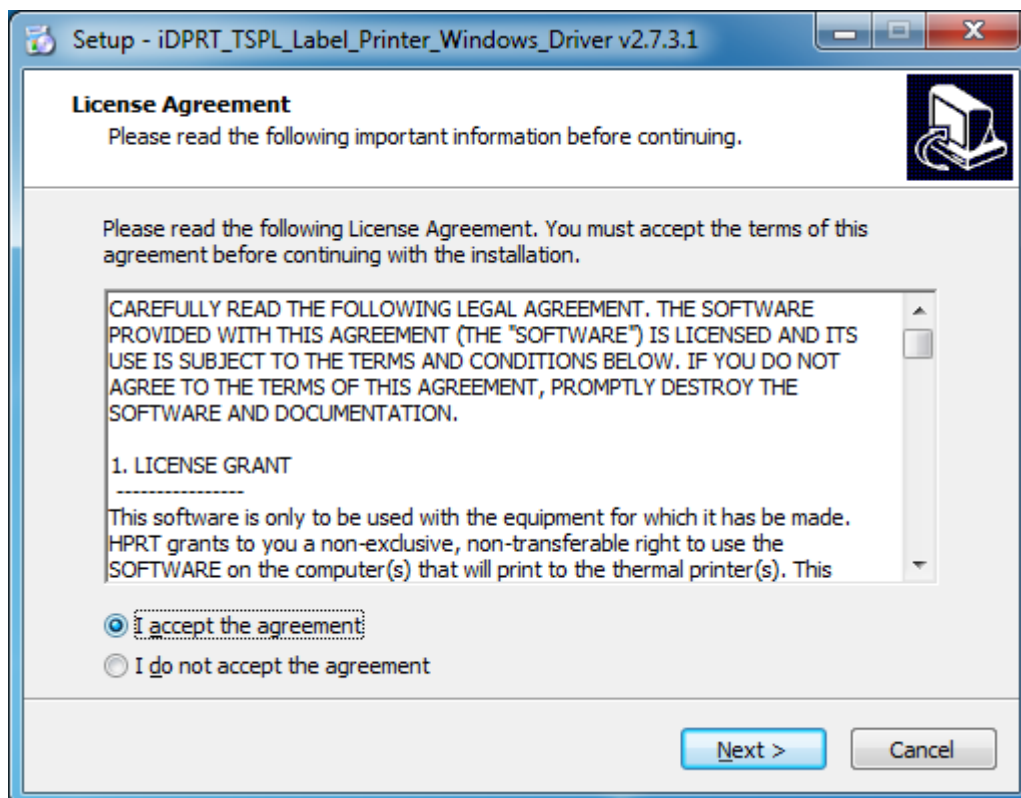

5. Select the default installation port name of printer driver, then click "Next".

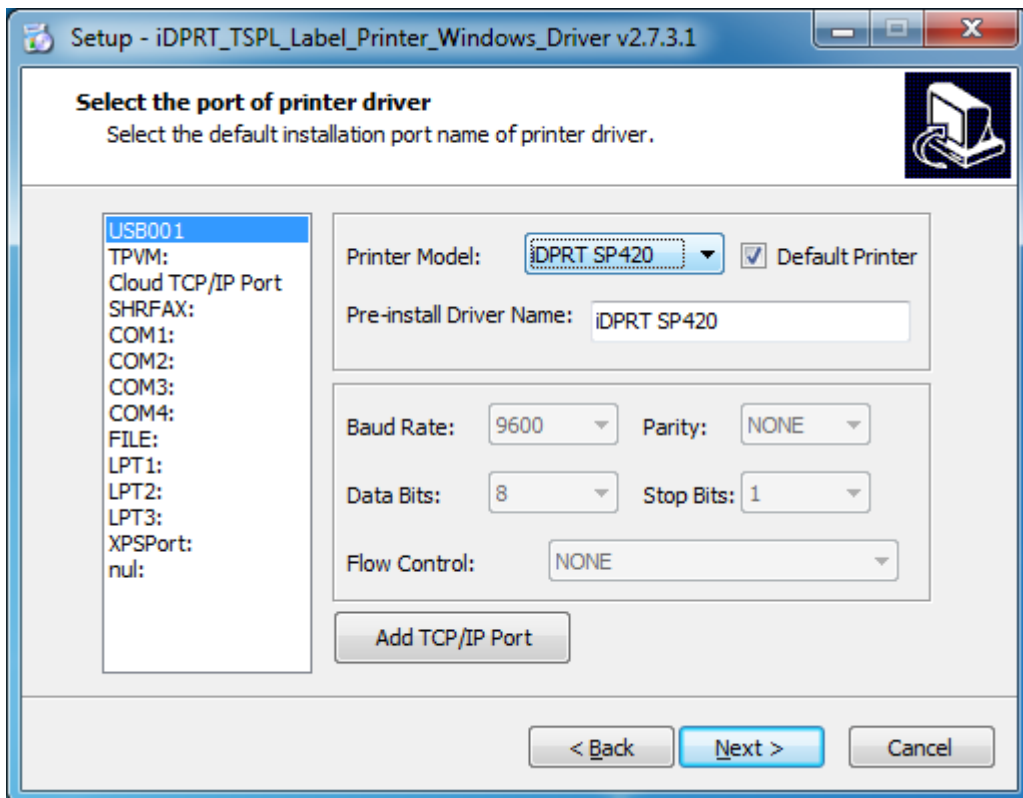

6. Click "Finish".

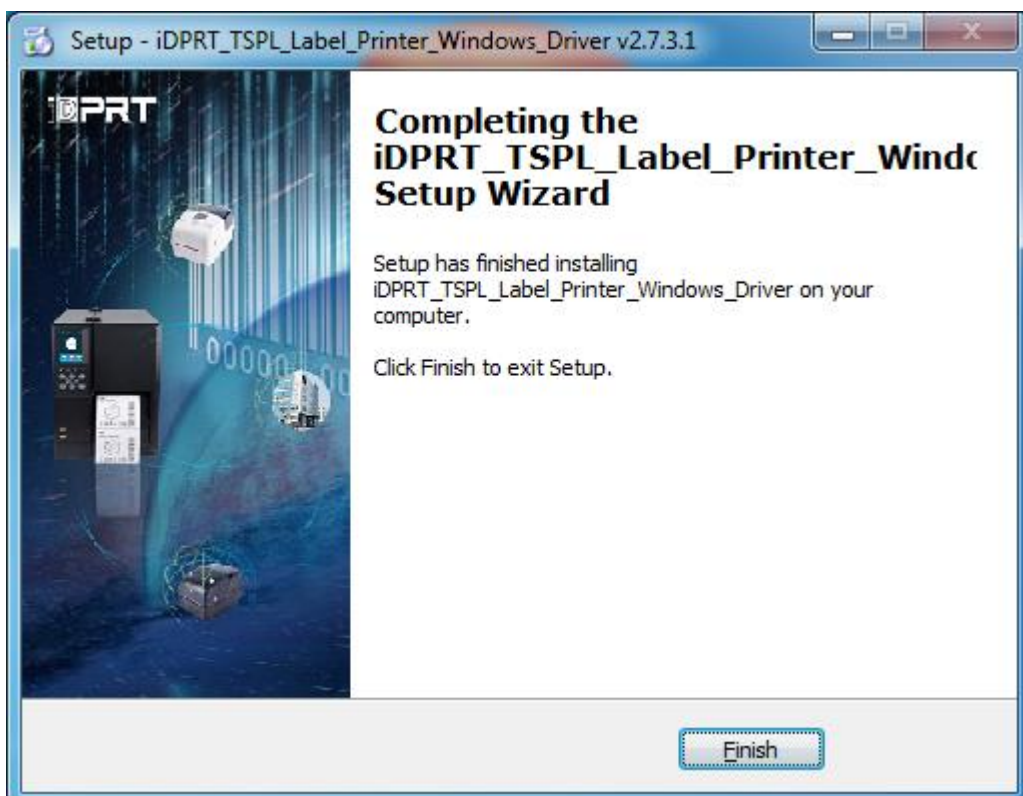

7. After installation, the icon will be found in “Start” → “Printers and Faxes”.



 **Note:**

- 1.If you already installed the driver (No matter what kind of port), when you connect the printer to computer, it will create a USB port automatically.**
- 2. Any problems please use our utility in the CD.**

7.4 Usage

7.4.1 Printing Preferences

1. Click “Start” → “Devices and Printers”. Right click the icon and choose “Printing preferences”.

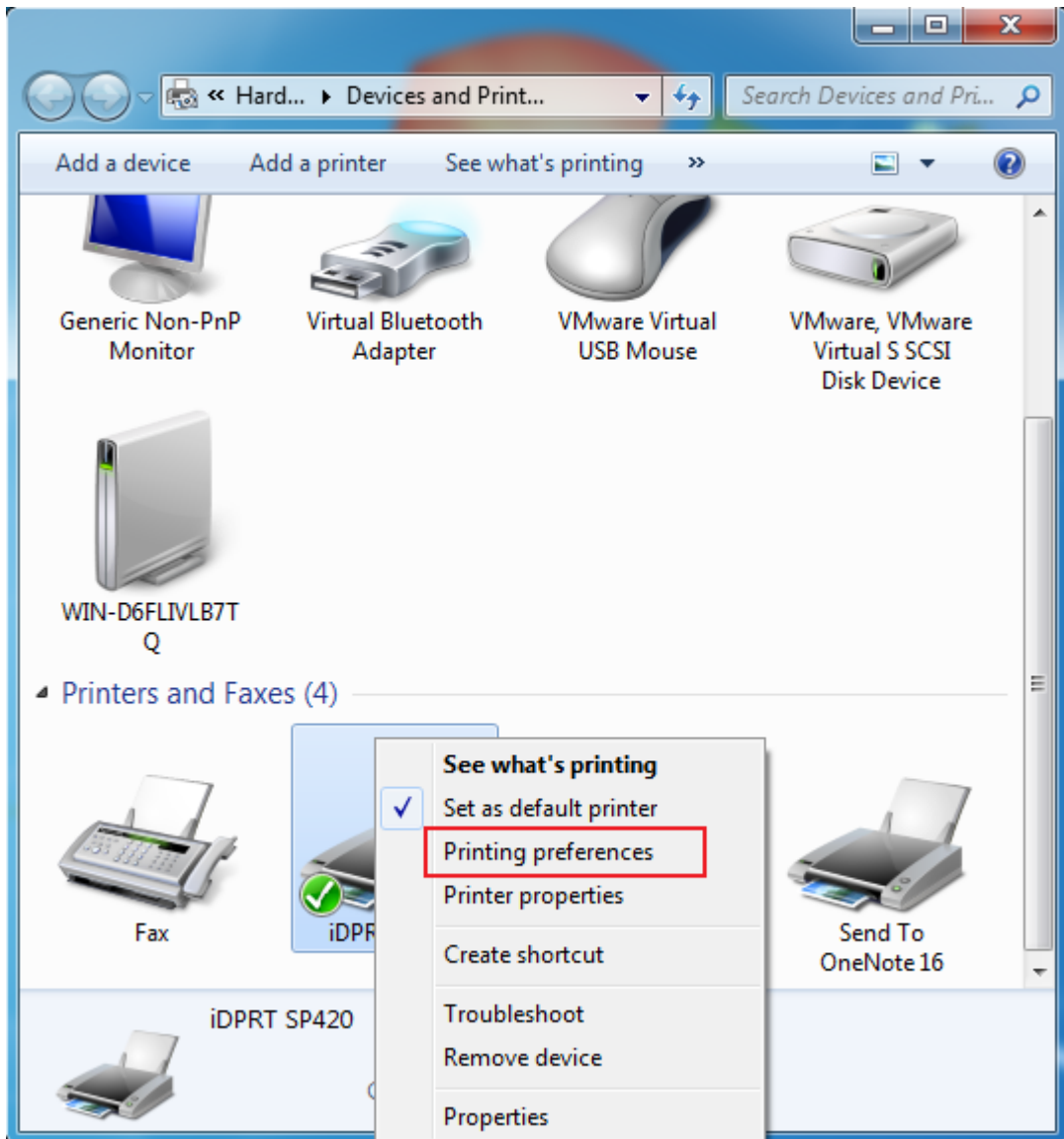

2. According to different needs, set the page.

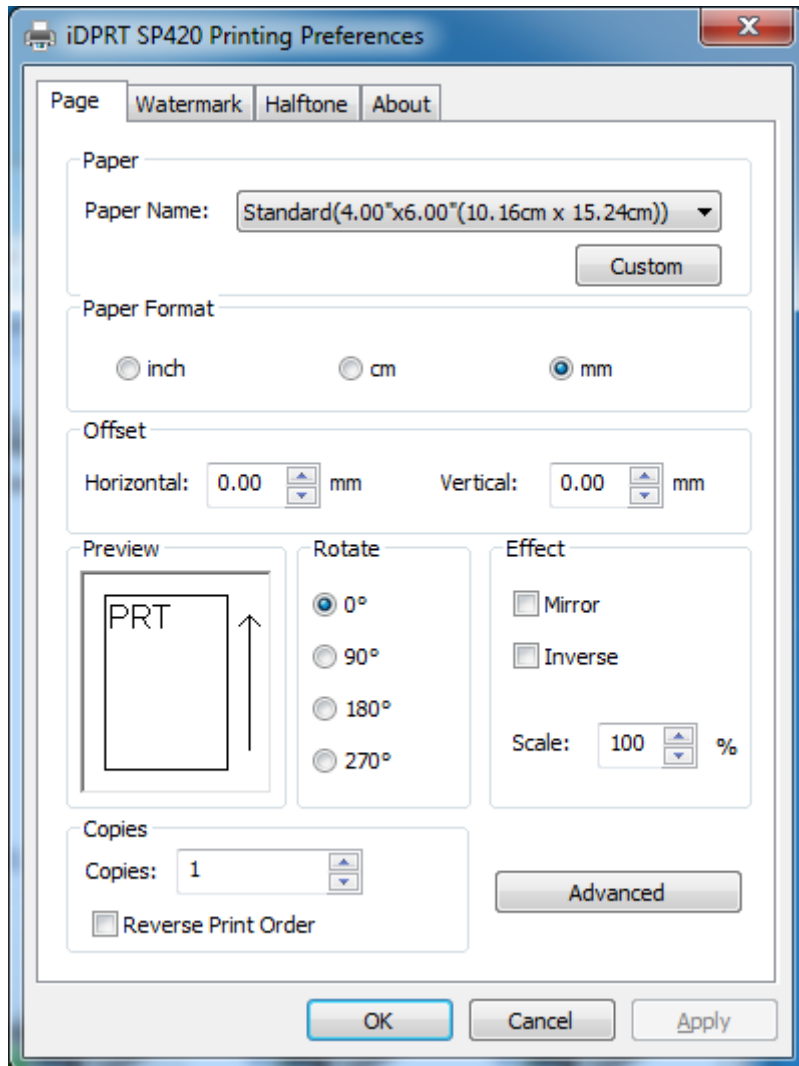

- Click “Paper Name”, then choose the paper type.

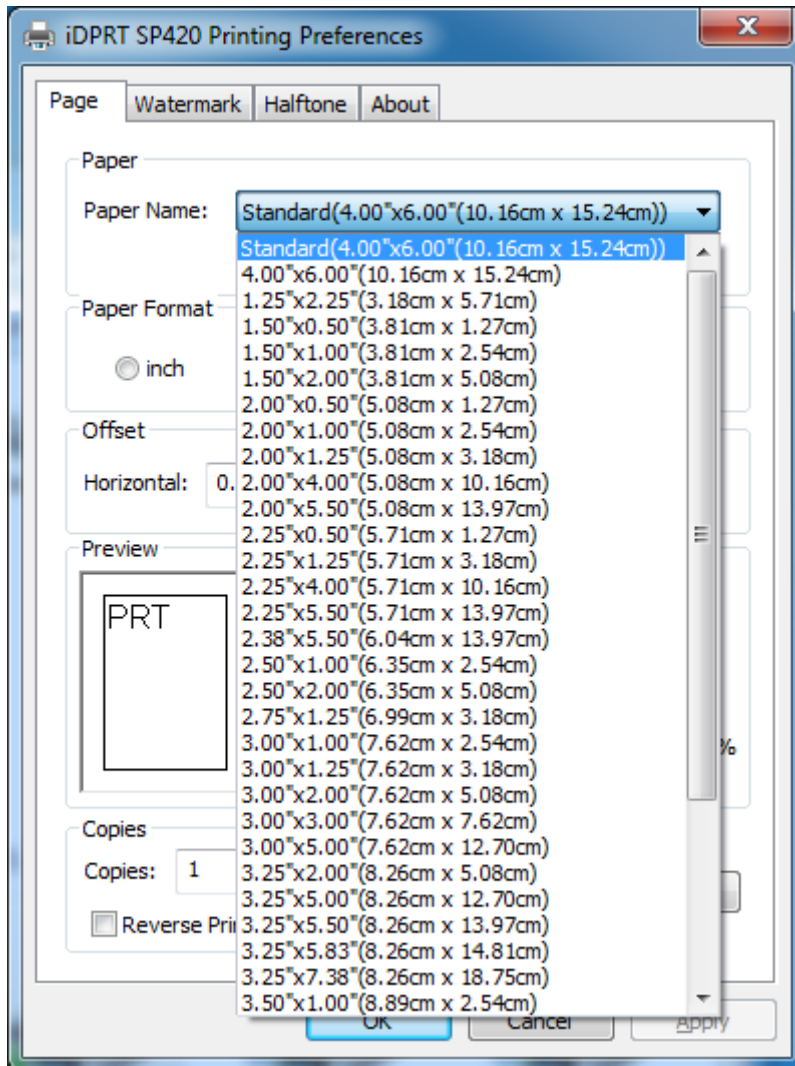

- Click “Manager” to add a new stock.

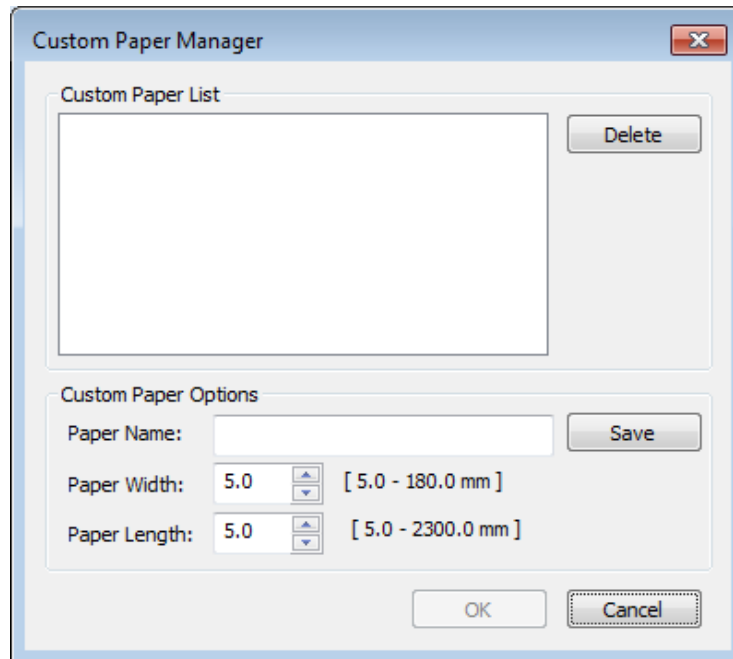

- Choose “Rotate” or “Effect”, it will be showed in the “Preview”.

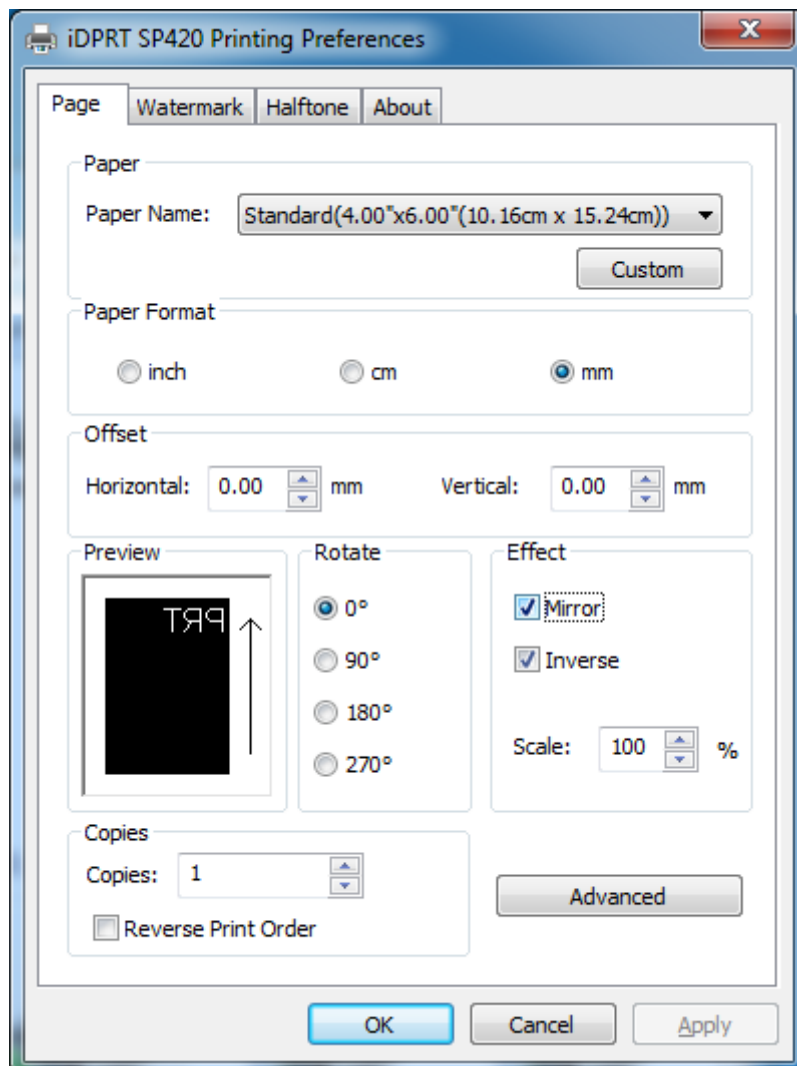

●Click “Advanced” to set “Save Paper”, “Density”, “Speed”, “Test”, “Media Handling”, “Media Type”.

1) Save Paper

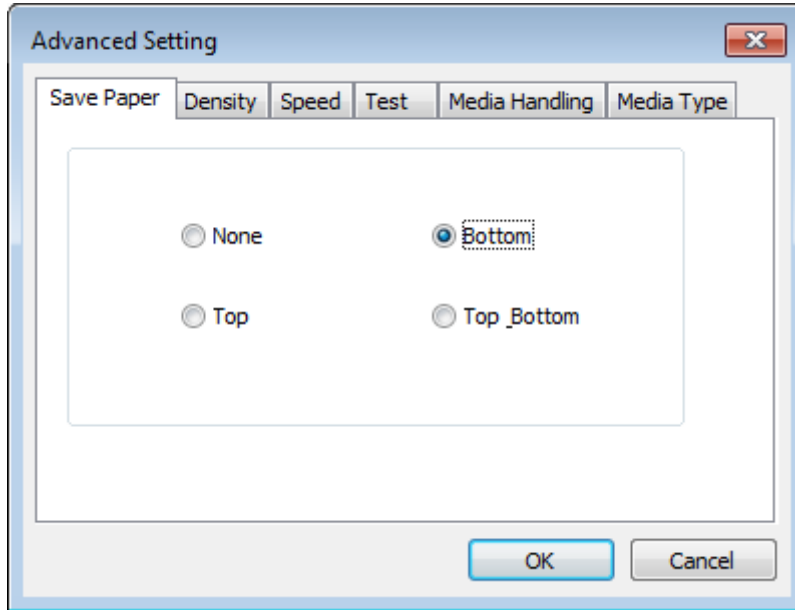

2) Density

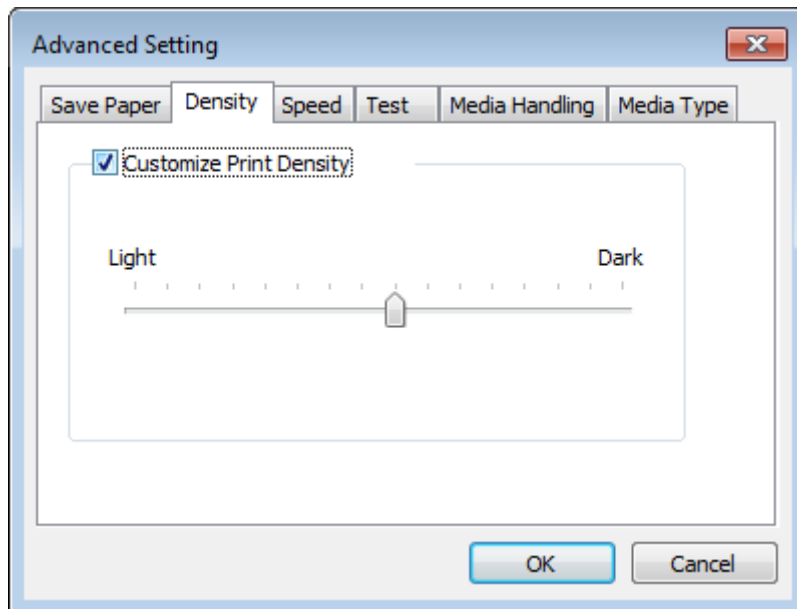

3) Speed

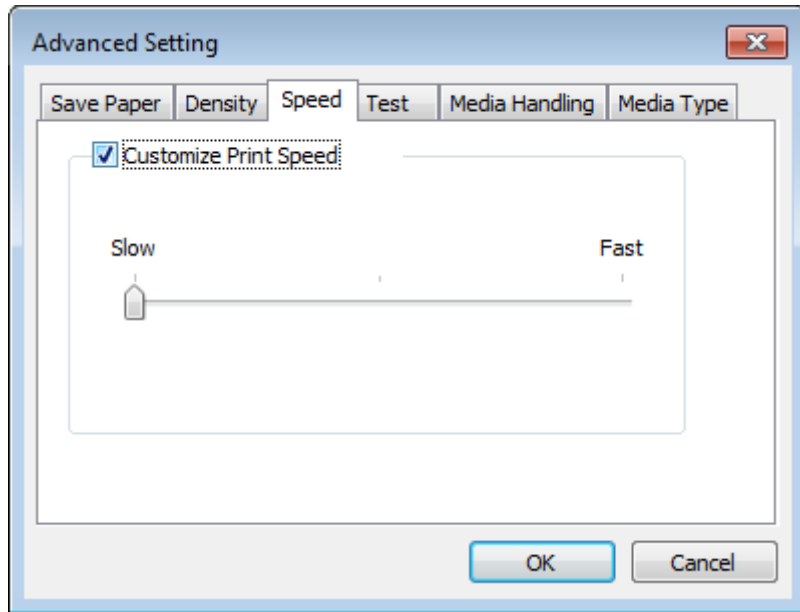

4) Test

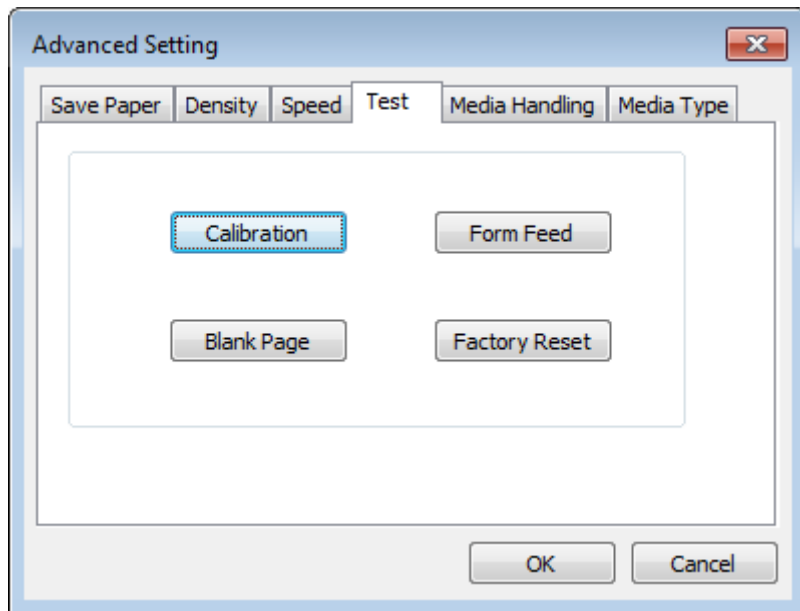

5) Media Handling

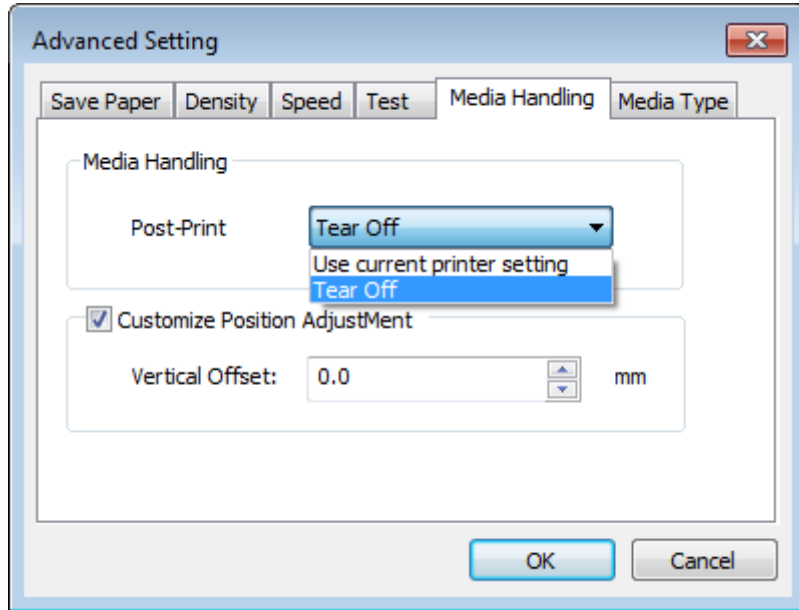

6) Media type

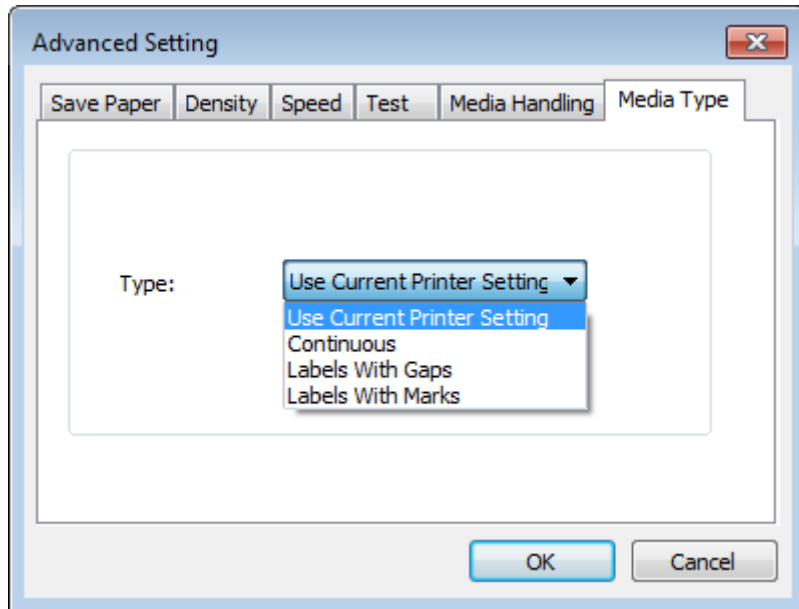

3. Click “Watermark”, it recommends to use BMP format.

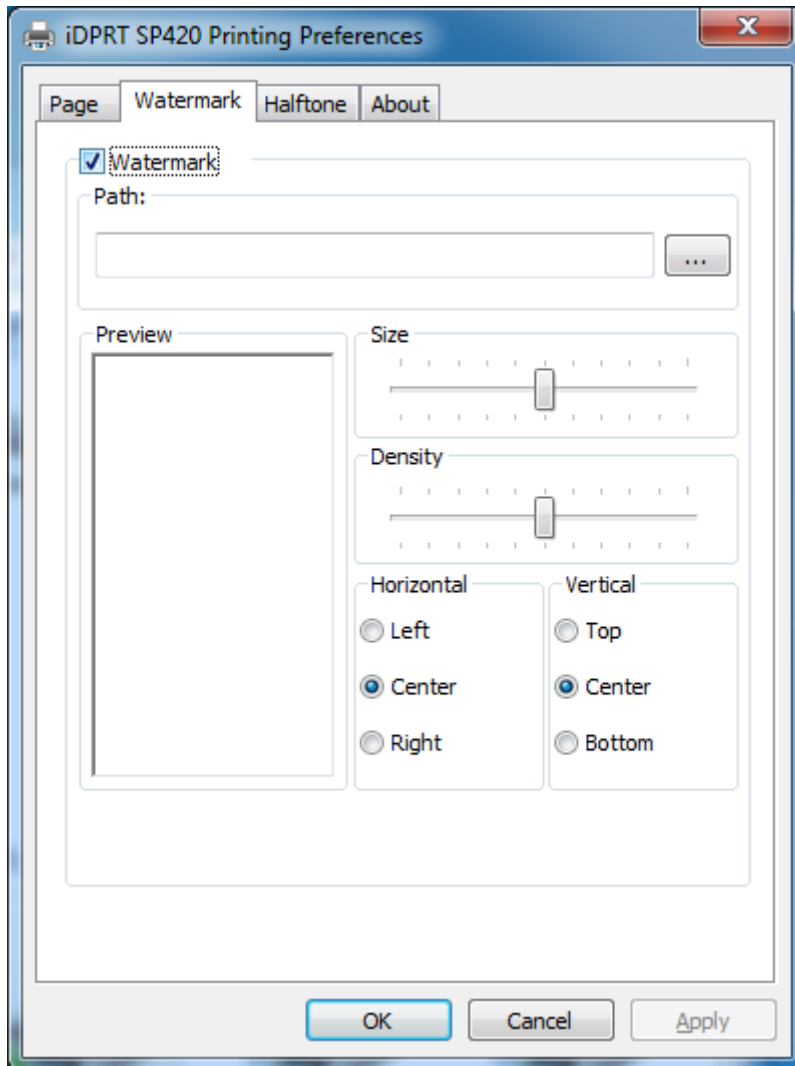

4. Click “Halftone”.

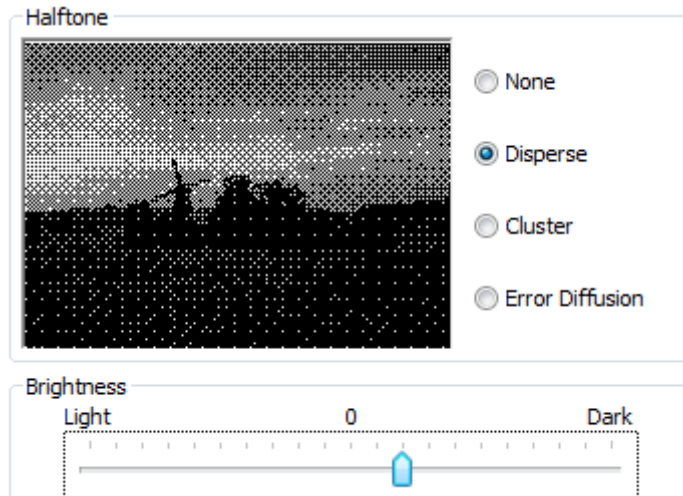
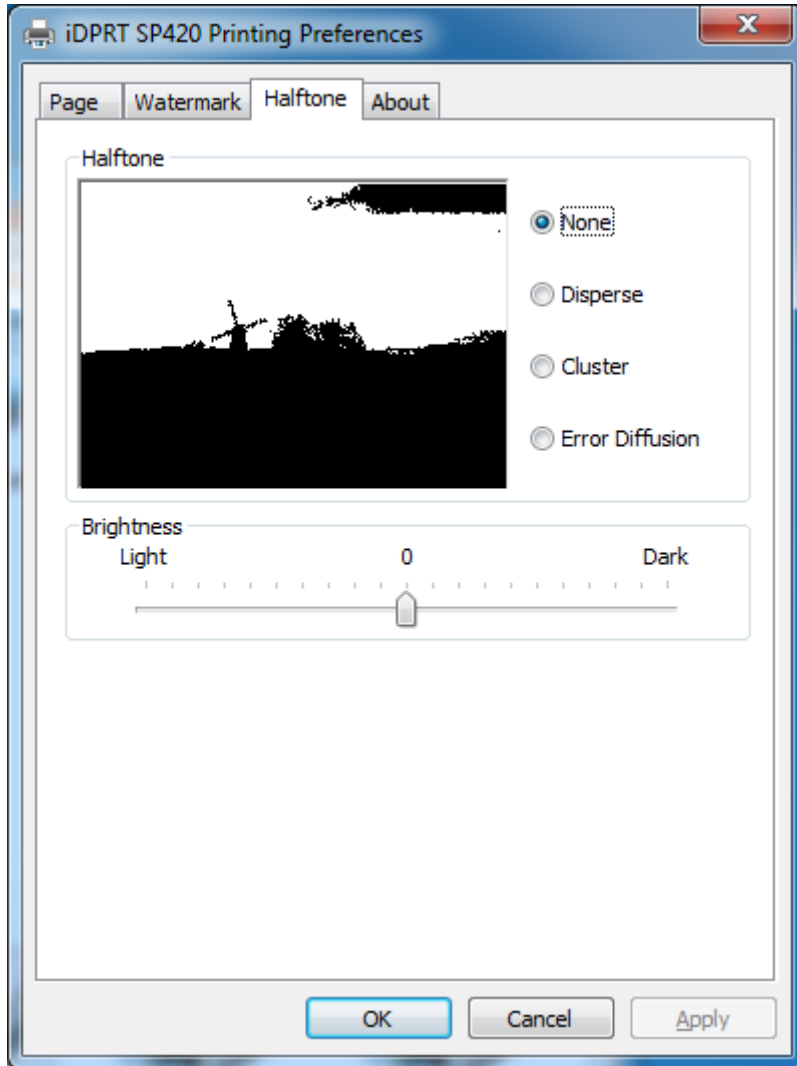

7.4.2 Printer Properties

1. Click “Start” → “Devices and Printers”. Right click the icon and choose “Printer properties”.

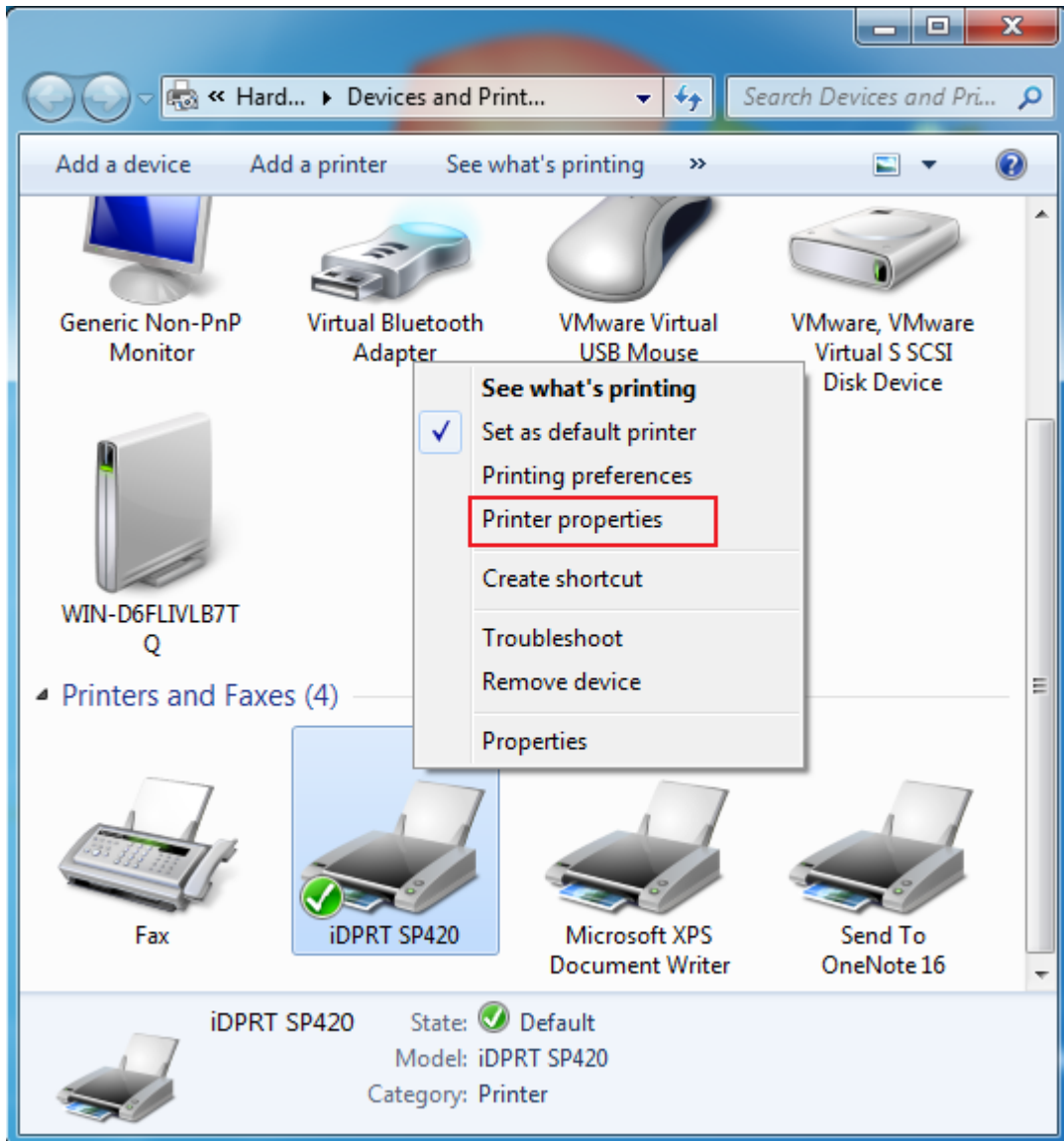

2. Click “General” → “Print Test Page”, and the printer will print the current settings.

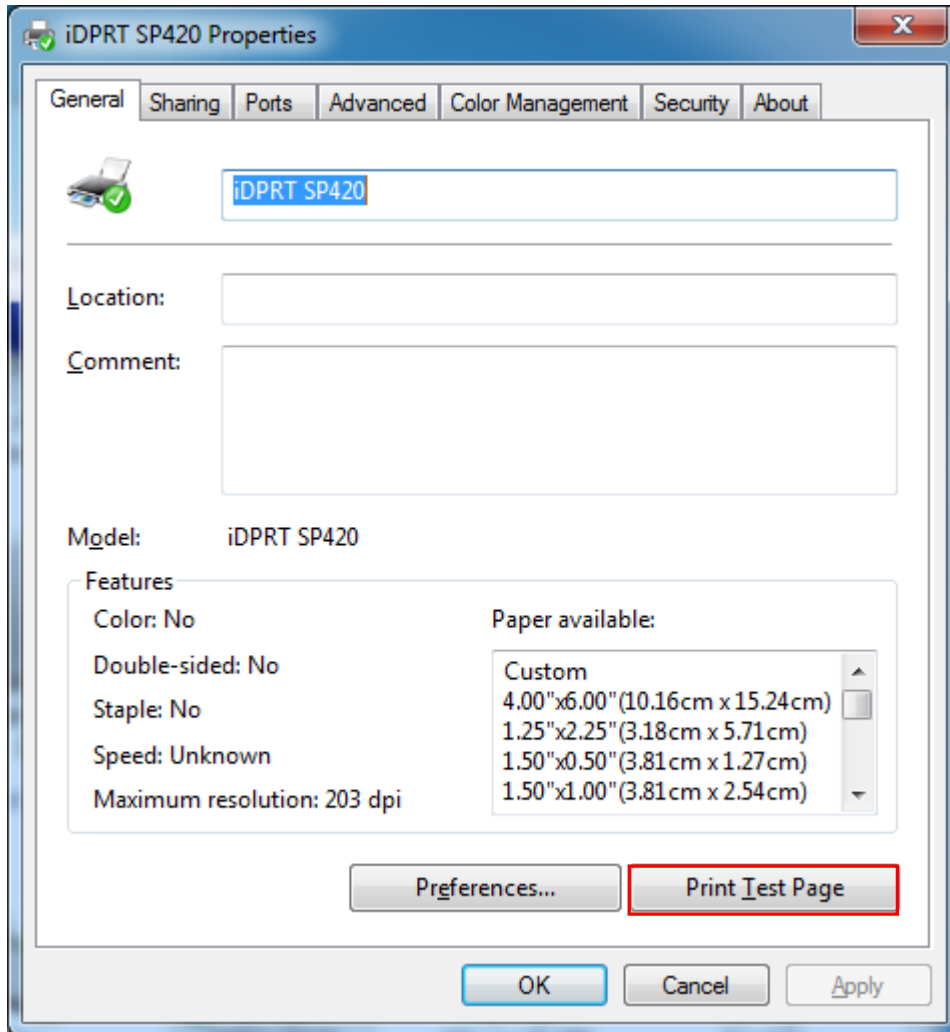

3. Click "Ports", then choose the port needed.

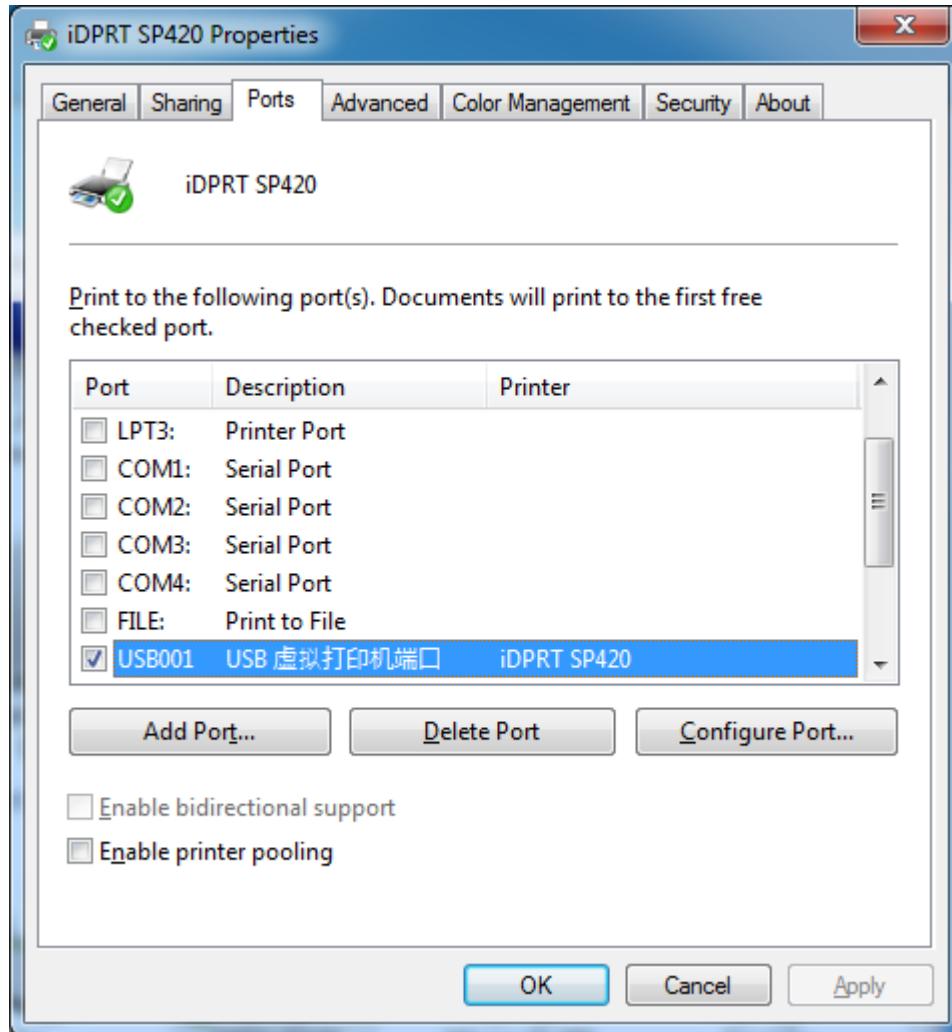

4. Click “Advanced” to set the available time for the printer.

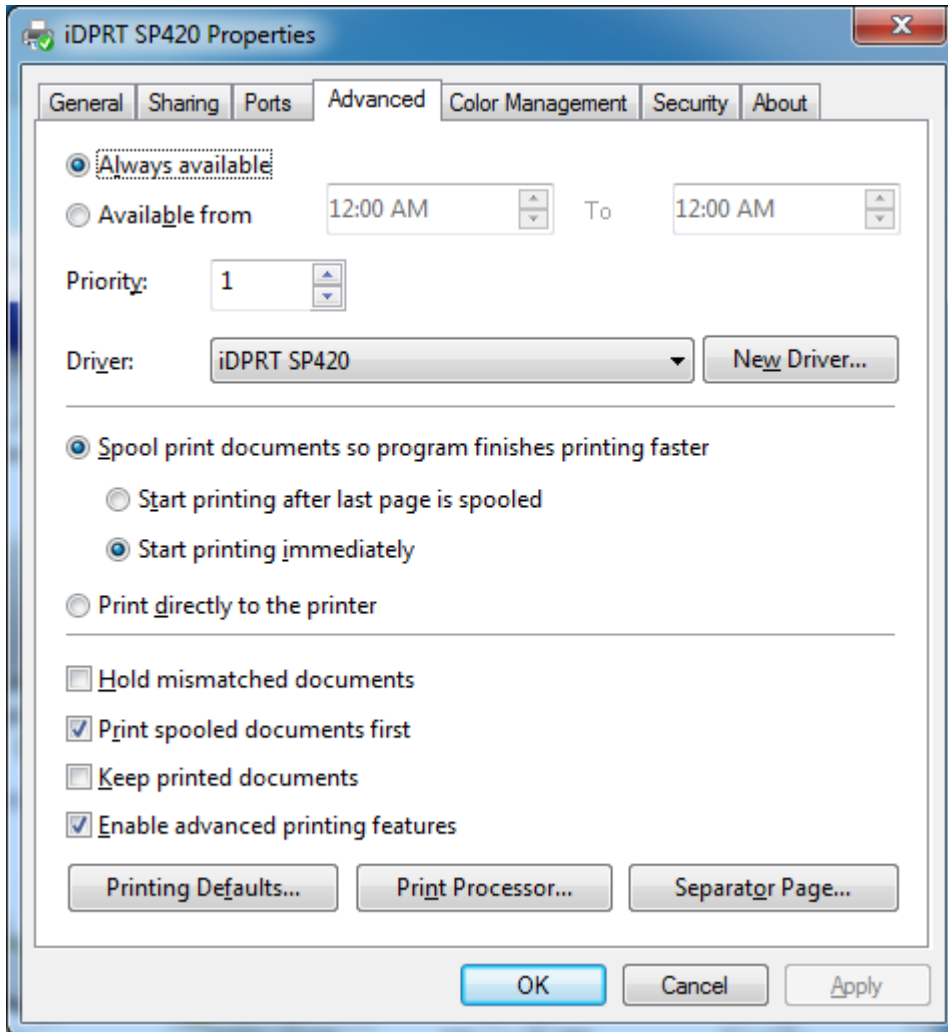

7.5 Removing



Note: Please turn off the printer or unplug the USB cable before removing the driver.

1. Double click Windows Driver.

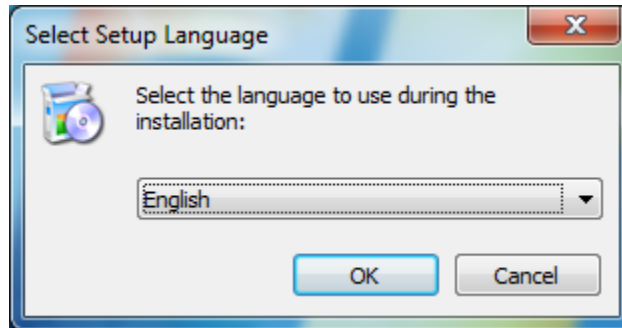

2. Choose "Uninstall printer driver", then click "Next".

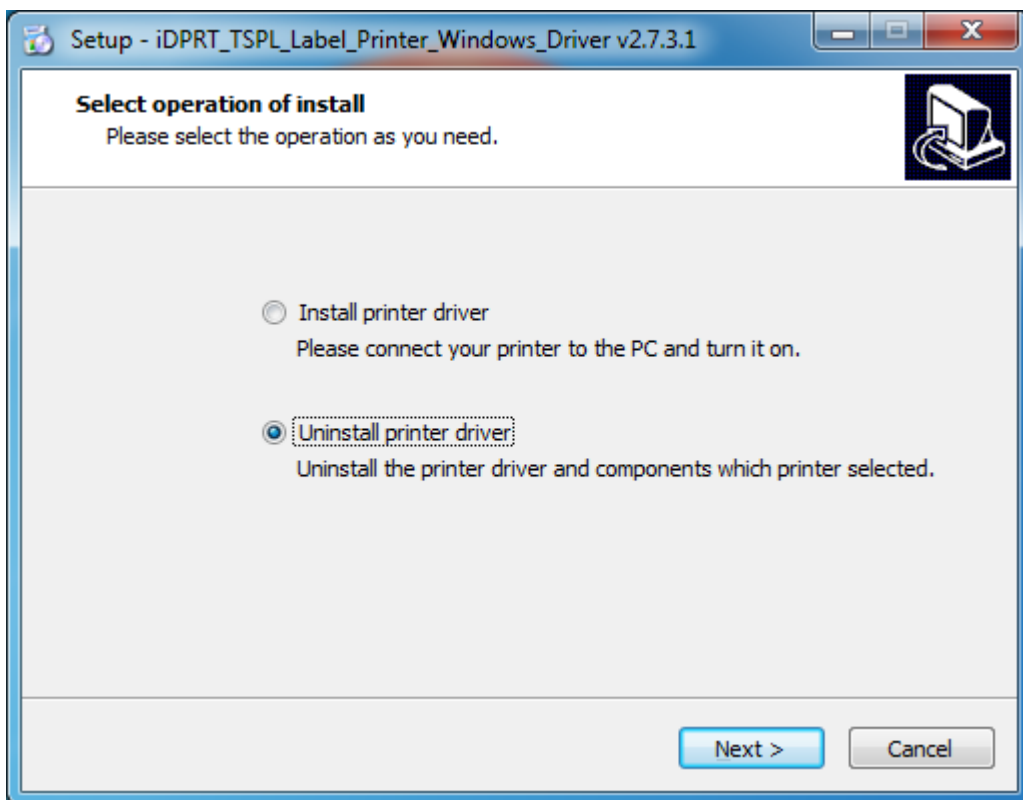

3. Choose the printer driver name needed to uninstall, then click "Next".

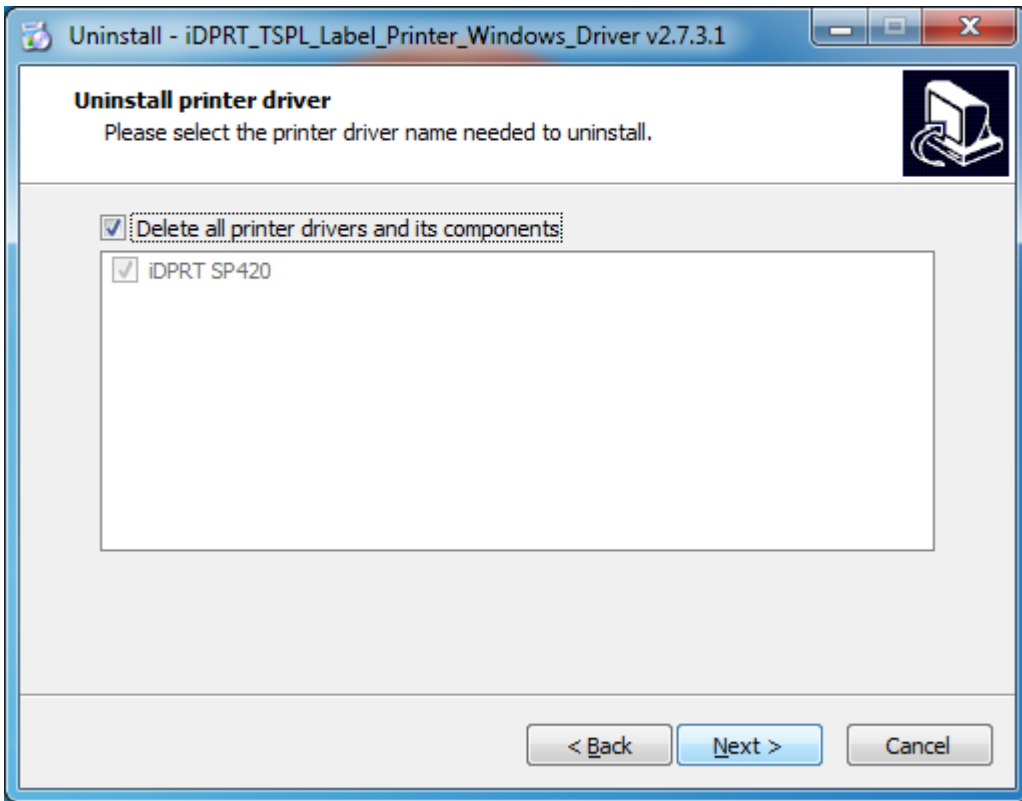

4. Click "Yes".

